

Dell™ PowerEdge™ SC430 Systems Installation and Troubleshooting Guide

[Introduction](#)

[Indicators, Messages, and Codes](#)

[Running the System Diagnostics](#)

[Troubleshooting Your System](#)

[Installing System Options](#)

[Installing Drives](#)

[Service Only Parts Replacement Procedures](#)

[Getting Help](#)

[Jumpers and Connectors](#)

[I/O Connectors](#)

Notes, Notices, and Cautions



NOTE: A NOTE indicates important information that helps you make better use of your computer.



NOTICE: A NOTICE indicates either potential damage to hardware or loss of data and tells you how to avoid the problem.



CAUTION: A CAUTION indicates a potential for property damage, personal injury, or death.

Abbreviations and Acronyms

For a complete list of abbreviations and acronyms, see the Glossary in your *User's Guide*.

Information in this document is subject to change without notice.

© 2005 Dell Inc. All rights reserved.

Reproduction in any manner whatsoever without the written permission of Dell Inc. is strictly forbidden.

Trademarks used in this text: *Dell*, the *DELL* logo, *Inspiron*, *Dell Precision*, *Dimension*, *OptiPlex*, *Latitude*, *PowerEdge*, *PowerVault*, *PowerConnect*, *DellNet*, and *PowerApp* are trademarks of Dell Inc.; *Microsoft* and *Windows* are registered trademarks and *Windows Server* is a trademark of Microsoft Corporation.; *EMC* is a registered trademark of EMC Corporation.

Other trademarks and trade names may be used in this document to refer to either the entities claiming the marks and names or their products. Dell Inc. disclaims any proprietary interest in trademarks and trade names other than its own.

Initial release: 13 Apr 2005

Jumpers and Connectors

Dell™ PowerEdge™ SC430 Systems Installation and Troubleshooting Guide

- [Jumpers—A General Explanation](#)
- [System Board Jumpers](#)
- [System Board Connectors](#)
- [Disabling a Forgotten Password](#)

This section provides specific information about the system jumpers. It also provides some basic information on jumpers and switches and describes the connectors on the various boards in the system.

Jumpers—A General Explanation

Jumpers provide a convenient and reversible way of reconfiguring the circuitry on a printed circuit board. When reconfiguring the system, you may need to change jumper settings on circuit boards or drives.

Jumpers

Jumpers are small blocks on a circuit board with two or more pins emerging from them. Plastic plugs containing a wire fit down over the pins. The wire connects the pins and creates a circuit. To change a jumper setting, pull the plug off its pin(s) and carefully fit it down onto the pin(s) indicated. [Figure A-1](#) shows an example of a two-pin jumper.

Figure A-1. Example Jumpers

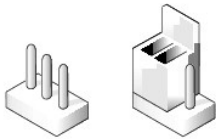

⚠ CAUTION: Ensure that the system is turned off before you change a jumper setting. Otherwise, damage to the system or unpredictable results may occur.

A jumper is referred to as open or unjumped when the plug is pushed down over only one pin or if there is no plug at all. When the plug is pushed down over two pins, the jumper is referred to as jumped.

[Figure A-2](#) shows the location and default settings of the system jumper blocks. See [Table A-1](#) for the designations, default settings, and functions of the system's jumpers.

System Board Jumpers

[Figure A-2](#) shows the location of the configuration jumpers on the system board. [Table A-1](#) lists the jumpers settings.

Figure A-2. System Board Jumpers

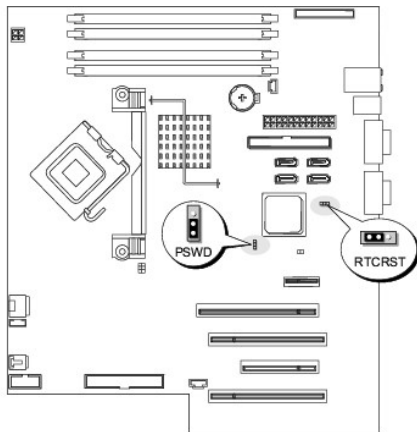





Table A-1. System Board Jumper Settings

Jumper	Setting	Description
PSWD	 (default)	The password feature is enabled.
		The password feature is disabled.
RTCST	 (default)	The configuration settings in NVRAM are retained at system boot.
		The configuration settings in NVRAM are cleared at next system boot.

System Board Connectors

See [Figure A-3](#) and [Table A-2](#) for the location and description of system board connectors. [Figure A-3](#) also indicates expansion slots and bus operating speeds.

Figure A-3. System Board Connectors

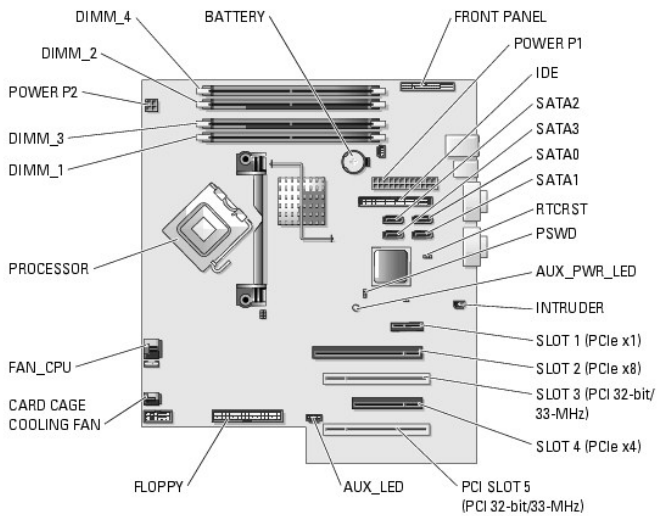

Table A-2. System Board Connectors

Connector	Description
AUX_LED	External LED connector
AUX_PWR_LED	Auxiliary power LED.
BATTERY	System battery
CARD CAGE COOLING FAN	Card-cage cooling fan
DIMM_x	Memory modules (4)
FAN_CPU	Processor fan connector
FLOPPY	Floppy drive
FRONT PANEL	Front-panel switches and indicators
I/O expansion cards	Expansion card slots: <ul style="list-style-type: none"> one PCI Express [x8] one PCI Express [x1] one PCI Express [x4] two 32-bit/33-MHz PCI
IDE	IDE drive connector
INTRUDER	Chassis intruder switch
POWER P1	Main power connector
POWER P2	Power connector (small)
PSWD	Password reset jumper. See Table A-1 .
RTCST	RTC reset jumper. See Table A-1 .

Disabling a Forgotten Password

The system's software security features include a system password and an admin password, which are discussed in detail in "Using the System Setup Program" in your *User's Guide*. The password jumper enables these password features or disables them and clears any password(s) currently in use.

⚠ CAUTION: Only trained service technicians are authorized to remove the system cover and access any of the components inside the system. Before performing any procedure, see your *Product Information Guide* for complete information about safety precautions, working inside the computer and protecting against electrostatic discharge.

1. Turn off the system, including any attached peripherals, and disconnect the system from the electrical outlet.
2. Open the system. See "[Opening the System](#)" in "Troubleshooting Your System."
3. Move the PSWD jumper to the disabled position. See [Figure A-2](#) and [Table A-1](#).
4. Close the system. See "[Closing the System](#)" in "Troubleshooting Your System."
5. Reconnect the system to its electrical outlet and turn the system on, including any attached peripherals.

The existing passwords are not disabled (erased) until the system boots with the password jumper plug in the disabled position. However, before you assign a new system and/or admin password, you must move the jumper to the enabled position.

6. Turn off the system, including any attached peripherals, and disconnect the system from the electrical outlet.
7. Open the system. See "[Opening the System](#)" in "Troubleshooting Your System".
8. Move the PSWD jumper from the disabled position to the enabled position. See [Figure A-2](#) and [Table A-1](#).
9. Close the system. See "[Closing the System](#)" in "Troubleshooting Your System".
10. Reconnect the system to its electrical outlet and turn the system on, including any attached peripherals.
11. Assign a new system and/or admin password.

To assign a new password using the System Setup program, see "Using the System Setup Program" in your *User's Guide*.

[Back to Contents Page](#)

I/O Connectors

Dell™ PowerEdge™ SC430 Systems Installation and Troubleshooting Guide

- [I/O Connectors](#)
- [Video Connector](#)
- [USB Connector](#)
- [Integrated NIC Connector](#)
- [Network Cable Requirements](#)

I/O Connectors

I/O connectors are the gateways that the system uses to communicate with external devices, such as a keyboard, mouse, printer, or monitor. This section describes the various connectors on your system. If you reconfigure the hardware connected to the system, you may also need the pin number and signal information for these connectors. [Figure B-1](#) shows the connectors on the back of the system.

Figure B-1. Back-Panel I/O Connectors

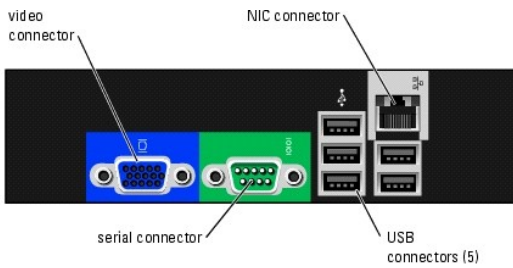

[Table B-1](#) shows the icons used to label the connectors on the system.

Table B-1. I/O Connector Icons

Icon	Connector
	Video connector
	Serial connector
	USB connector
	NIC connector

Video Connector

You can attach a VGA-compatible monitor to the system's integrated video controller using a 15-pin high-density D-subminiature connector. [Figure B-2](#) illustrates the pin numbers for the video connector and [Table B-2](#) defines the pin assignments for the connector.

Figure B-2. Video Connector Pin Numbers

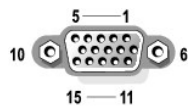

Table B-2. Video Connector Pin Assignments

Pin	Signal	I/O	Definition
1	RED	O	Red video
2	GREEN	O	Green video
3	BLUE	O	Blue video

4	NC	N/A	No connection
5-8, 10	GND	N/A	Signal ground
9	VCC	N/A	Vcc
11	NC	N/A	No connection
12	DDC data out	O	Monitor detect data
13	HSYNC	O	Horizontal synchronization
14	VSYNC	O	Vertical synchronization
15	NC	N/A	No connection

USB Connector

The system's USB connector supports USB-compliant peripherals such as keyboards, mice, and printers and may also support USB-compliant devices such as diskette drives, CD drives, and compact flash drives. [Figure B-3](#) illustrates the pin numbers for the USB connector and [Table B-3](#) defines the pin assignments for the connector.

NOTE: Your system provides five USB connectors on the back panel and two USB connectors on the front panel.

NOTICE: Do not attach a USB device or a combination of USB devices that draw a maximum current of more than 500 mA per channel or +5 V. Attaching devices that exceed this threshold may cause the USB connectors to shut down. See the documentation that accompanied the USB devices for their maximum current ratings.

Figure B-3. USB Connector Pin Numbers



Table B-3. USB Connector Pin Assignments

Pin	Signal	I/O	Definition
1	Vcc	N/A	Supply voltage
2	DATA	I	Data in
3	+DATA	O	Data out
4	GND	N/A	Signal ground

Integrated NIC Connector

The system's integrated NIC functions as a separate network expansion card while providing fast communication between servers and workstations. [Figure B-4](#) illustrates the pin numbers for the NIC connector and [Table B-4](#) defines the pin assignments for the connector.

Figure B-4. NIC Connector

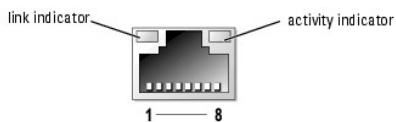

Table B-4. NIC Connector Pin Assignments

Pin	Signal	I/O	Definition
1	TD+	O	Data out (+)
2	TD-	O	Data out (-)
3	RD+	I	Data in (+)
4	NC	N/A	No connection
5	NC	N/A	No connection
6	RD-	I	Data in (-)
7	NC	N/A	No connection
8	NC	N/A	No connection

Network Cable Requirements

The NIC supports a UTP Ethernet cable equipped with a standard RJ45-compatible plug. Observe the following cabling restrictions.

🔔 **NOTICE:** To avoid line interference, voice and data lines must be in separate sheaths.

- 1 Use Category 5 or greater wiring and connectors.
- 1 Do not exceed a cable run length (from a workstation to a hub) of 100 m (328 ft).



For detailed guidelines on operation of a network, see "Systems Considerations of Multi-Segment Networks" in the IEEE 802.3 standard.

[Back to Contents Page](#)

[Back to Contents Page](#)

Dell™ PowerEdge™ SC430 Systems Installation and Troubleshooting Guide

Notes, Notices, and Cautions

-  **NOTE:** A NOTE indicates important information that helps you make better use of your computer.
 -  **NOTICE:** A NOTICE indicates either potential damage to hardware or loss of data and tells you how to avoid the problem.
 -  **CAUTION:** A CAUTION indicates a potential for property damage, personal injury, or death.
-

Abbreviations and Acronyms

For a complete list of abbreviations and acronyms, see the Glossary in your *User's Guide*.

Information in this document is subject to change without notice.
© 2005 Dell Inc. All rights reserved.

Reproduction in any manner whatsoever without the written permission of Dell Inc. is strictly forbidden.

Trademarks used in this text: *Dell*, the *DELL* logo, *Inspiron*, *Dell Precision*, *Dimension*, *OptiPlex*, *Latitude*, *PowerEdge*, *PowerVault*, *PowerConnect*, *DellNet*, and *PowerApp* are trademarks of Dell Inc.; *Microsoft* and *Windows* are registered trademarks and *Windows Server* is a trademark of Microsoft Corporation.; *EMC* is a registered trademark of EMC Corporation.

Other trademarks and trade names may be used in this document to refer to either the entities claiming the marks and names or their products. Dell Inc. disclaims any proprietary interest in trademarks and trade names other than its own.

[Back to Contents Page](#)

[Back to Contents Page](#)

Introduction

Dell™ PowerEdge™ SC430 Systems Installation and Troubleshooting Guide

[Other Information You May Need](#)

The following upgrade options are available for your system:

- 1 Processor
- 1 Memory
- 1 PCI or PCIe expansion cards
- 1 SATA hard drives
- 1 SCSI hard drives
- 1 SCSI controller
- 1 Optical drive
- 1 Tape backup drive
- 1 Diskette drive

Your system also includes system diagnostics, which checks for hardware problems (if the system can boot).

Other Information You May Need

 The *Product Information Guide* provides important safety and regulatory information. Warranty information may be included within this document or as a separate document.

- 1 The *Getting Started Guide* provides an overview of initially setting up your system.
- 1 The *User's Guide* provides information about system features and technical specifications.
- 1 CDs included with your system provide documentation and tools for configuring and managing your system.
- 1 Systems management software documentation describes the features, requirements, installation, and basic operation of the software.
- 1 Operating system documentation describes how to install (if necessary), configure, and use the operating system software.
- 1 Documentation for any components you purchased separately provides information to configure and install these options.
- 1 Updates are sometimes included with the system to describe changes to the system, software, and/or documentation.

 **NOTE:** Always check for updates on support.dell.com and read the updates first because they often supersede information in other documents.

- 1 Release notes or readme files may be included to provide last-minute updates to the system or documentation or advanced technical reference material intended for experienced users or technicians.
-

[Back to Contents Page](#)

Indicators, Messages, and Codes

Dell™ PowerEdge™ SC430 Systems Installation and Troubleshooting Guide

- [Front-Panel Indicators and Features](#)
- [Back-Panel Indicators and Features](#)
- [NIC Indicator Codes](#)
- [Power Supply Features](#)
- [System Messages](#)
- [System Beep Codes](#)
- [Warning Messages](#)
- [Diagnostics Messages](#)
- [Alert Messages](#)

The system, applications, and operating systems can identify problems and alert you to them. Any of the following can indicate when the system is not operating properly:

- 1 System indicators
- 1 System messages
- 1 Beep codes
- 1 Warning messages
- 1 Diagnostics messages
- 1 Alert messages

This section describes each type of message, lists the possible causes, and provides steps to resolve any problems indicated by a message. The system indicators and features are illustrated in this section.

Front-Panel Indicators and Features

[Figure 2-1](#) shows the front-panel indicators for hard-drive activity, diagnostics, and local area network (LAN) activity. The power button has a status indicator built into the button. Also, the optional diskette drive has an activity indicator.

[Table 2-1](#) details the conditions associated with each front-panel indicator code. [Table 2-2](#) details the conditions associated with the diagnostic indicator codes.

Figure 2-1. Front-Panel Indicators and Features

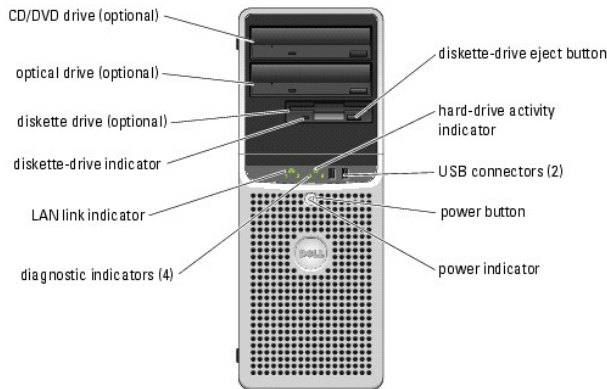

Table 2-1. Front-Panel Indicator Codes

Indicator Type	Activity Indicator	Indicator Code
Power	Off	The system is off.
	Amber blinking	The system is powering up. If the hard-drive indicator is off, the power supply may need to be replaced. If the hard-drive indicator is on, the system board is faulty. Check the diagnostic indicators to see if the specific problem is identified. See Table 2-2 .
	Solid amber	The power supply is probably good. Check the diagnostic indicators to see if the specific problem is identified. See Table 2-2 .
	Solid green	Indicates that the system is powered on.

	Green blinking	The system is in a low power state. Check the diagnostic indicators to see if the specific problem is identified. See Table 2-2 .
Diskette drive	Green blinking	Indicates diskette-drive activity.
Hard drive	Green blinking	Indicates hard-drive activity.
LAN link	Solid green	Indicates network is linked.

The front panel also incorporates two USB 2.0 connectors. See [Figure 2-1](#).

Diagnostics Indicator Codes

The four diagnostic indicator lights on the system front panel display error codes during system startup. [Table 2-2](#) lists the causes and possible corrective actions associated with these codes. A highlighted circle indicates the light is on; a non-highlighted circle indicates the light is off.

 **NOTE:** Once the system completes POST, all diagnostic lights will be OFF.

Table 2-2. Diagnostic Indicator Codes

Code	Causes	Corrective Action
① ② ③ ④	Possible processor failure.	See " Troubleshooting the Microprocessor " in "Troubleshooting Your System."
① ② ③ ④	Memory failure.	See " Troubleshooting System Memory " in "Troubleshooting Your System."
① ② ③ ④	Possible expansion card failure.	See " Troubleshooting Expansion Cards " in "Troubleshooting Your System."
① ② ③ ④	Possible video failure.	See " Getting Help ."
① ② ③ ④	Diskette drive or hard drive failure.	Ensure that the diskette drive and hard drive are properly connected. See " Installing Drives " for information on the drives installed in your system.
① ② ③ ④	Possible USB failure.	See " Troubleshooting a USB Device " in "Troubleshooting Your System."
① ② ③ ④	No memory modules detected.	See " Troubleshooting System Memory " in "Troubleshooting Your System."
① ② ③ ④	System board failure.	See " Getting Help ."
① ② ③ ④	Memory configuration error.	See " Troubleshooting System Memory " in "Troubleshooting Your System."
① ② ③ ④	Possible system board resource and/or system board hardware failure.	See " Troubleshooting IRQ Assignment Conflicts " in "Troubleshooting Your System." If the problem persists, see " Getting Help ."
① ② ③ ④	Possible system resource configuration error.	See " Troubleshooting Your System ." If the problem persists, see " Getting Help ."
① ② ③ ④	Other failure.	Ensure that the diskette drive, optical drive, and hard drives are properly connected. See " Troubleshooting Your System " for the appropriate drive installed in your system. If the problem persists, see " Getting Help ."
① ② ③ ④	BIOS checksum failure detected; system is in recovery mode.	Ensure that all network cards and connections are functioning properly. See " Troubleshooting Your System ." If the problem persists, see " Getting Help ."
① ② ③ ④	The system is in a normal operating condition after POST.	Information only.

Back-Panel Indicators and Features

Figure 2-2 shows the back-panel indicators and features. Figure 2-3 shows the indicators for the integrated network adapter and Table 2-4 details the conditions associated with the indicators.

Figure 2-2. Back-Panel Indicators and Features

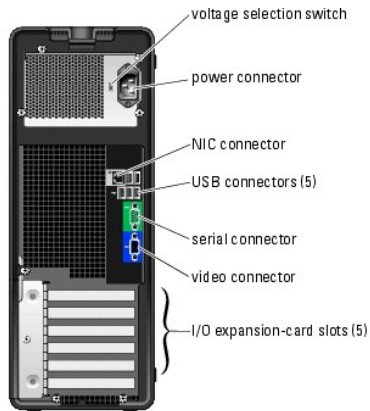

NIC Indicator Codes

Figure 2-3. NIC Indicators

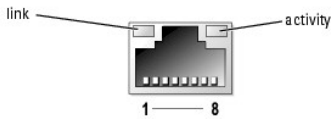

Table 2-3. NIC Indicators

Indicator Type	Indicator Code	Description
Activity	Off	When off at the same time that the link indicator is off, the NIC is not connected to the network or the NIC is disabled in the System Setup program. See "Using the System Setup Program" in your <i>User's Guide</i> .
	Blinking	Indicates that network data is being sent or received.
Link	Off	When off at the same time that the activity indicator is off, the NIC is not connected to the network or the NIC is disabled in the System Setup program. See "Using the System Setup Program" in your <i>User's Guide</i> .
	Yellow	1000-Mbps connection
	Orange	100-Mbps connection
	Green	10-Mbps connection

Power Supply Features

The voltage selection switch on the back panel of the system allows you to select one of two primary voltage inputs. Ensure that the switch is set to the proper voltage according to Table 2-4.

Table 2-4. Voltage Selection Switch

If your power source is:	The voltage selection switch should be set to:
110 V	115
220 V	230

For information on system power requirements, see "Technical Specifications" in your *User's Guide*.

System Messages

System messages appear on the screen to notify you of a possible problem with the system. [Table 2-5](#) lists the system messages that can occur and the probable cause and corrective action for each message.

 **NOTE:** If you receive a system message that is not listed in [Table 2-5](#), check the documentation for the application that is running when the message appears or the operating system's documentation for an explanation of the message and recommended action.

Table 2-5. System Messages

Message	Causes	Corrective Actions
A filename cannot contain any of the following characters: \ / : * ? " < >		Do not use these characters in filenames.
A required .DLL file was not found	The application that you are trying to open is missing an essential file.	Remove and then reinstall the application. See the application's documentation for installation instructions.
Alert! CPU fan not detected	The processor cooling fan is faulty or the fan assembly is not installed correctly.	Ensure that the processor cooling shroud is properly installed. See " Cooling Fans " in "Installing System Options."
Alert! Rear fan failure	Cooling fan is faulty or the fan assembly is not installed correctly.	See " Cooling Fans " in "Installing System Options."
Alert! Previous reboot was due to voltage regulator failure		See " Getting Help ."
Alert! System battery voltage is low		Replace the battery. See " Troubleshooting the System Battery " in "Troubleshooting Your System."
Alert! Unable to initialize all installed memory	One or more memory modules might be faulty or improperly seated.	See " Troubleshooting System Memory " and "Troubleshooting Your System." If the problem persists, see " Getting Help ."
System halted! Mixing ECC and non-ECC DIMMs is not supported on this platform		See " Troubleshooting System Memory " and "Troubleshooting Your System." If the problem persists, see " Getting Help ."
Alert! Cover was previously removed.	The system was opened.	Information only. To reset the chassis intrusion switch, see "Using the System Setup Program" in your <i>User's Guide</i> .
Alert! CPU 0 fan failure.	The processor cooling fan is faulty or the fan assembly is not installed correctly.	Ensure that the processor cooling shroud is properly installed. See " Cooling Fans " in "Installing System Options."
Alert! Card-cage fan failure	A card-cage fan is not detected during POST. The system will halt at the <F1>/<F2> prompt even if Keyboard Errors Report option is disabled in the System Setup program.	See " Cooling Fans " in "Installing System Options."
Alert! Error initializing PCI Express slot n (or bridge).	The system encountered a problem while trying to configure a PCIe expansion card	See " Troubleshooting Expansion Cards " in "Troubleshooting Your System."
Alert! OS Install Mode enabled. Amount of available memory limited to 256MB	The OS Install Mode option in the System Setup program is set to On . This limits the amount of available memory to 256 MB because some operating systems will not complete installation with more than 2 GB of system memory.	After the operating system is installed, enter the System Setup program and set the OS Install Mode option to Off . See your <i>User's Guide</i> for details.
Alert! Previous fan failure.	The fan caused errors the last time the system was used.	Ensure that nothing is blocking the airflow vents and that all fans are properly installed and operating correctly.
Alert! Previous attempts at booting this system have failed at checkpoint [nnnn]. For help in resolving this problem, please note this checkpoint and contact Dell Technical Support	The system failed to complete the boot routine three consecutive times for the same error.	See " Getting Help ."
Alert! Previous Processor Thermal Failure	The processor overheated the last time the system was used.	Ensure that nothing is blocking the airflow vents and that all fans are properly installed and operating correctly. Also, ensure that the processor heat sink is properly installed. See " Microprocessor " in "Installing System Options."
Alert! Previous Shutdown Due to Thermal Event	The processor or hard drive overheated the last time the system was used.	Ensure that nothing is blocking the airflow vents and that all fans are working correctly. Also, ensure that the processor heat sink is properly installed. See " Microprocessor " in "Installing System Options."
Alert! Uncorrectable Memory Error Previously Detected	One or more memory modules might be improperly seated or faulty, or the system board may be faulty.	See " Troubleshooting System Memory " and "Troubleshooting Your System." If the problem persists, see " Getting Help ."
Attachment failed to respond	The diskette or hard-drive controller cannot send data to the associated drive.	See " Troubleshooting a Diskette Drive ," " Troubleshooting SATA Hard Drives ," or " Troubleshooting SCSI Hard Drives " in "Troubleshooting Your System."

Bad command or file name		Ensure that you have spelled the command correctly, have put spaces in the proper place, and have used the correct pathname.
Bad error-correction code (ECC) on disk read	The diskette or hard-drive controller detected an uncorrectable read error.	See " Troubleshooting a Diskette Drive ," " Troubleshooting SATA Hard Drives ," or " Troubleshooting SCSI Hard Drives " in "Troubleshooting Your System."
bb/dd/f: Error allocating IRQ for PCI Device bb/dd/f: Error allocating I/O BAR for PCI Device bb/dd/f: Error allocating Mem BAR for PCI Device bb/dd/f: Error allocating PMem BAR for PCI Device bb/dd/f: Error allocating UMB for PCI Device where bb is the bus number, dd is the device number, and f is the function number. NOTE: bb, dd, and f are hexadecimal numbers.	The system encountered a problem while trying to configure an expansion card or integrated on-board devices.	If the device number points to an expansion card, the card can be removed. See " Troubleshooting Expansion Cards " in "Troubleshooting Your System." If the device number points to a an on-board device, disable the device. See "Using the System Setup Program" in your <i>User's Guide</i> for details.
Controller has failed	The hard drive or the associated controller is defective.	See " Troubleshooting SATA Hard Drives " or " Troubleshooting SCSI Hard Drives " in "Troubleshooting Your System."
Data error	The diskette drive or hard drive cannot read the data.	For the operating system, run the appropriate utility to check the file structure of the diskette drive or hard drive. See your operating system documentation for information on running these utilities.
Decreasing available memory	One or more memory modules might be faulty or improperly seated.	Reinstall the memory modules and, if necessary, replace them. See " Memory " in "Installing System Options." See " Troubleshooting System Memory " in "Troubleshooting Your System."
Diskette drive 0 seek failure	A cable might be loose or the system configuration information might not match the hardware configuration.	See " Troubleshooting a Diskette Drive " in "Troubleshooting Your System."
Diskette read failure	The diskette might be defective, or a cable might be loose.	If the diskette-drive indicator turns on, try a different disk. See " Troubleshooting a Diskette Drive " in "Troubleshooting Your System."
Diskette subsystem reset failed	The diskette drive controller might be faulty.	Run the system diagnostics. See " Running the System Diagnostics ."
Diskette write protected	The diskette is write-protected.	Slide the write-protect notch to the open position.
Drive not ready	No diskette is in the drive.	Insert a diskette in the drive.
Floppy diskette seek failure	A diskette drive is not connected but is enabled in the BIOS setup menu.	See " Troubleshooting a Diskette Drive " in "Troubleshooting Your System."
Gate A20 failure	Faulty keyboard controller (faulty system board).	See " Getting Help ."
General failure	The operating system is unable to carry out the command.	This message is usually followed by specific information. Take the appropriate action to resolve the problem.
Hard-disk configuration error Hard-disk controller failure Hard-disk drive failure	The hard drive failed initialization.	Run the system diagnostics. See " Running the System Diagnostics ." See " Troubleshooting SATA Hard Drives " or " Troubleshooting SCSI Hard Drives " in "Troubleshooting Your System."
Drive x not found: Serial (or Parallel) ATA, SATA-(or PATA-)n	x is the drive number (0-6) and n is SATA0-4 or PATA0-1	Run the system diagnostics. See " Running the System Diagnostics ." See " Troubleshooting SATA Hard Drives " in "Troubleshooting Your System."
Insert bootable media	The operating system is trying to boot from a nonbootable diskette or CD.	Insert a bootable diskette or CD.
Invalid configuration information - please run SETUP program	The system configuration information does not match the hardware configuration.	Enter the System Setup program and correct the system configuration information. See your <i>User's Guide</i> for details.
Keyboard Controller Failure Keyboard Stuck Key Failure Keyboard failure	A cable or connector might be loose, or the keyboard or keyboard/mouse controller might be faulty.	See " Troubleshooting the Keyboard " in "Troubleshooting Your System."

Memory address line failure at <i>address</i> , read value expecting value	A memory module might be faulty or improperly seated.	Reinstall the memory modules and, if necessary, replace them. See " Troubleshooting System Memory " in "Troubleshooting Your System."
Memory allocation error	The software you are attempting to run is conflicting with the operating system, another program, or a utility.	Turn off the system, wait 30 seconds, restart the system, and then try to run the program again. If the error message appears again, see the software documentation for additional troubleshooting suggestions.
Memory data line failure at <i>address</i> , read value expecting value Memory double word logic failure at <i>address</i> , read value expecting value Memory odd/even logic failure at <i>address</i> , read value expecting value Memory write/read failure at <i>address</i> , read value expecting value	A memory module might be faulty or improperly seated.	Reinstall the memory modules and, if necessary, replace them. See " Troubleshooting System Memory " in "Troubleshooting Your System."
Memory size in CMOS invalid	The amount of memory recorded in the system configuration information does not match the memory installed in the system.	Restart the system. If the error message appears again, see " Troubleshooting System Memory " in "Troubleshooting Your System." If the problem persists, see " Getting Help ."
No boot device available	The system cannot find the diskette or hard drive.	If the diskette drive is your boot device, ensure that a bootable disk is in the drive. If the hard drive is your boot device, ensure that the hard drive is installed, properly seated, and partitioned as a boot device. Enter the System Setup program and verify the boot sequence information. See your <i>User's Guide</i> for details.
No boot sector on hard-disk drive	The system configuration information in the System Setup program might be incorrect.	Enter the System Setup program and verify the system configuration information for the hard drive. See your <i>User's Guide</i> for details. If the message continues to appear after verifying the information in the System Setup program, the operating system might have been corrupted. Reinstall the operating system. See your operating system documentation for reinstallation information.
No timer tick interrupt	A chip on the system board might be malfunctioning.	Run the system diagnostics. See " Running the System Diagnostics ."
Non-system disk or disk error	The diskette in the diskette drive or your hard drive does not have a bootable operating system installed on it.	Replace the diskette with one that has a bootable operating system or remove the diskette, and then restart the system. If the problem persists, see the appropriate hard drive troubleshooting procedure: " Troubleshooting SATA Hard Drives " or " Troubleshooting SCSI Hard Drives " in "Troubleshooting Your System." If the problem persists, see " Getting Help ."
Not a boot diskette	The operating system is trying to boot from a diskette that does not have a bootable operating system installed on it.	Insert a diskette that has a bootable operating system.
Not enough memory or resources. Close some programs and try again	You have too many programs open.	Close all windows and open the program that you want to use. In some cases, you might have to restart your system to restore system resources. If so, try opening the program that you want to use first
Operating system not found		See " Getting Help ."
Please connect USB keyboard/mouse to USB ports on the back of the computer	The keyboard and/or mouse is not properly connected.	See " Troubleshooting a USB Device ."
Plug and play configuration error	An attached device is improperly configured.	See " Troubleshooting Your System ."
Read fault	The operating system cannot read from the diskette or hard drive, the system could not find a particular sector on the disk, or the requested sector is defective.	See " Troubleshooting SATA Hard Drives " or " Troubleshooting SCSI Hard Drives " in "Troubleshooting Your System."
Requested sector not found	The operating system cannot read from the diskette or hard drive, the system could not find a particular sector on the disk, or the requested sector is defective.	See " Troubleshooting a Diskette Drive ," " Troubleshooting SATA Hard Drives ," or " Troubleshooting SCSI Hard Drives " in "Troubleshooting Your System."
Reset failed	The disk reset operation failed.	See " Troubleshooting a Diskette Drive ," " Troubleshooting SATA Hard Drives ," or " Troubleshooting SCSI Hard Drives " in "Troubleshooting Your System."
Sector not found	A faulty diskette drive or hard drive.	See " Troubleshooting a Diskette Drive ."

Seek error		" Troubleshooting SATA Hard Drives ," or " Troubleshooting SCSI Hard Drives " in "Troubleshooting Your System."
Shutdown failure	A chip on the system board might be malfunctioning.	Run the system diagnostics. See " Running the System Diagnostics ."
The file being copied is too large for the destination drive	The file that you are trying to copy is too large to fit on the disk.	Try copying the file to a blank diskette or using a larger capacity disk.
Time-of-day clock stopped	The battery might be faulty.	See " Troubleshooting the System Battery " in "Troubleshooting Your System."
Time-of-day not set	The time or date stored in the System Setup program does not match the system clock.	Enter the System Setup program and correct the Date and Time options. See your <i>User's Guide</i> for details. If the problem persists, see " Troubleshooting the System Battery " in "Troubleshooting Your System."
Timer chip counter 2 failed	A chip on the system board might be malfunctioning.	Run the system diagnostics. See " Running the System Diagnostics ."
NOTICE: The [primary/secondary/primary serial] IDE [master/slave] hard drive SELF MONITORING SYSTEM has reported that a parameter has exceeded its normal operating range. Dell recommends that you back up your data regularly. A parameter out of range may or may not indicate a potential hard drive problem.	During initial start-up, the drive detected possible error conditions.	When your system finishes booting, immediately back up your data and replace your hard drive. See " Installing SATA or SCSI Hard Drives " in "Installing Drives." If no replacement hard drive is immediately available and the drive is not the only bootable drive, enter the System Setup program and change the appropriate drive setting to Off . See your <i>User's Guide</i> for details. Then remove the hard drive from the system.
Write fault	The operating system cannot write to the diskette drive or hard drive.	See " Troubleshooting a Diskette Drive ," " Troubleshooting SATA Hard Drives ," or " Troubleshooting SCSI Hard Drives " in "Troubleshooting Your System."
Write fault on selected drive	The operating system cannot write to the diskette drive or hard drive.	See " Troubleshooting a Diskette Drive ," " Troubleshooting SATA Hard Drives ," or " Troubleshooting SCSI Hard Drives " in "Troubleshooting Your System."
x:\ is not accessible. The device is not ready	The diskette drive cannot read the diskette.	Insert a diskette into the drive and try again.

System Beep Codes

If an error that cannot be reported on the screen occurs during POST, the system may emit a series of beeps that identifies the problem.

 **NOTE:** If the system boots without a keyboard, mouse, or monitor attached, the system does not issue beep codes related to those peripherals.

If a beep code is emitted, write down the series of beeps and then look it up in [Table 2-6](#). If you are unable to resolve the problem by looking up the meaning of the beep code, use system diagnostics to identify the possible cause. If you are still unable to resolve the problem, see "[Getting Help](#)."

Table 2-6. Server Module Beep Codes

Code	Cause	Corrective Action
1-1-2	CPU register test failure	See " Troubleshooting the Microprocessor " in "Troubleshooting Your System."
1-1-3	CMOS write/read failure; faulty system board	Faulty system board. See " Getting Help ."
1-1-4	BIOS checksum failure	
1-2-1	Programmable interval-timer failure; faulty system board	
1-2-2	DMA initialization failure	
1-2-3	DMA page register write/read failure	See " Troubleshooting System Memory " in "Troubleshooting Your System."
1-3-1	Main-memory refresh verification failure	
1-3-2	No memory installed	
1-3-3	Chip or data line failure in the first 64 KB of main memory	
1-3-4	Odd/even logic failure in the first 64 KB of main memory	
1-4-1	Address line failure in the first 64 KB of main memory	
1-4-2	Parity failure in the first 64 KB of main memory	
1-4-3	Fail-safe timer test failure	
1-4-4	Software NMI port test failure	
2-1-1 through	Bit failure in the first 64 KB of main memory	

2-4-4		
3-1-1	Slave DMA-register failure	Faulty system board. See " Getting Help ."
3-1-2	Master DMA-register failure	
3-1-3	Master interrupt-mask register failure	
3-1-4	Slave interrupt-mask register failure	
3-2-2	Interrupt vector loading failure	
3-2-4	Keyboard-controller test failure	
3-3-1	CMOS failure	
3-3-2	System configuration check failure	
3-3-3	Keyboard controller not detected	
3-3-4	Video memory test failure	
3-4-1	Screen initialization failure	
3-4-2	Screen-retrace test failure	
3-4-3	Video ROM search failure	
4-2-1	No timer tick	
4-2-2	Shutdown test failure	
4-2-3	Gate A20 failure	
4-2-4	Unexpected interrupt in protected mode	
4-3-1	Improperly installed or faulty memory modules	See " Troubleshooting System Memory " in "Troubleshooting Your System."
4-3-2	No memory modules installed in the first memory module connector	Install a memory module in the first memory module connector. See " Installing a Memory Module " and " Memory Module Installation Guidelines " in "Installing System Options."
4-3-3	Faulty system board	Faulty system board. See " Getting Help ."
4-3-4	Time-of-day clock stopped	See " Troubleshooting the System Battery " in "Troubleshooting Your System." If the problem persists, see " Getting Help ."
4-4-1	Super I/O chip failure; faulty system board	Faulty system board. See " Getting Help ."
4-4-4	Cache test failure; faulty processor	See " Troubleshooting the Microprocessor " in "Troubleshooting Your System."

Warning Messages

A warning message alerts you to a possible problem and prompts you to respond before the system continues a task. For example, before you format a diskette, a message will warn you that you may lose all data on the diskette. Warning messages usually interrupt the task and require you to respond by typing y (yes) or n (no).

 **NOTE:** Warning messages are generated by either the application or the operating system. For more information, see the documentation that accompanied the operating system or application.

Diagnostics Messages

When you run system diagnostics, an error message may result. Diagnostic error messages are not covered in this section. Record the message on a copy of the Diagnostics Checklist in "[Getting Help](#)," and then follow the instructions in that section for obtaining technical assistance.

Alert Messages

Systems management software generates alert messages for your system. Alert messages include information, status, warning, and failure messages for drive, temperature, fan, and power conditions. For more information, see the systems management software documentation.

[Back to Contents Page](#)

[Back to Contents Page](#)

Running the System Diagnostics

Dell™ PowerEdge™ SC430 Systems Installation and Troubleshooting Guide

- [Using Server Administrator Diagnostics](#)
- [System Diagnostics Features](#)
- [When to Use the System Diagnostics](#)
- [Running the System Diagnostics](#)
- [System Diagnostics Testing Options](#)
- [Using the Custom Test Options](#)

If you experience a problem with your system, run the diagnostics before calling for technical assistance. The purpose of the diagnostics is to test your system's hardware without requiring additional equipment or risking data loss. If you are unable to fix the problem yourself, service and support personnel can use diagnostics test results to help you solve the problem.

Using Server Administrator Diagnostics

To assess a system problem, first use the online Server Administrator diagnostics. If you are unable to identify the problem, then use the system diagnostics.

To access the online diagnostics, log into the Server Administrator home page, and then click the **Diagnostics** tab. For information about using diagnostics, see the online help. For additional information, see the *Server Administrator User's Guide*.

System Diagnostics Features

The system diagnostics provides a series of menus and options for particular device groups or devices. The system diagnostics menus and options allow you to:

- 1 Run tests individually or collectively.
 - 1 Control the sequence of tests.
 - 1 Repeat tests.
 - 1 Display and print test results.
 - 1 Temporarily suspend testing if an error is detected or terminate testing when a user-defined error limit is reached.
 - 1 View help messages that briefly describe each test and its parameters.
 - 1 View status messages that inform you if tests are completed successfully.
 - 1 View error messages that inform you of problems encountered during testing.
-

When to Use the System Diagnostics

If a major component or device in the system does not operate properly, component failure may be indicated. As long as the microprocessor and the system's input/output devices (monitor, keyboard, and optional diskette drive) are functioning, you can use the system diagnostics to help identify the problem.

Running the System Diagnostics

The system diagnostics is run from the utility partition on your hard drive.

 **NOTICE:** Use the system diagnostics to test only your system. Using this program with other systems may cause invalid results or error messages. In addition, use only the program that came with your system (or an updated version of that program).

1. As the system boots, press <F10> during POST.
2. From the utility partition main menu, select **Run System Diagnostics**, or select **Run Memory Diagnostics** if you are troubleshooting memory.

When you start the system diagnostics, a message is displayed stating that the diagnostics are initializing. Next, the **Diagnostics** menu appears. The menu allows you to run all or specific diagnostics tests or to exit the system diagnostics.

 **NOTE:** Before you read the rest of this section, start the system diagnostics so that you can see the utility on your screen.

System Diagnostics Testing Options

Click the testing option in the **Main Menu** window. [Table 3-1](#) provides a brief explanation of testing options.

Table 3-1. System Diagnostics Testing Options

Testing Option	Function
Express Test	Performs a quick check of the system. This option runs device tests that do not require user interaction. Use this option to quickly identify the source of your problem.
Extended Test	Performs a more thorough check of the system. This test can take an hour or longer.
Custom Test	Tests a particular device.
Information	Displays test results.

Using the Custom Test Options

When you select **Custom Test** in the **Main Menu** window, the **Customize** window appears and allows you to select the device(s) to be tested, select specific options for testing, and view the test results.

Selecting Devices for Testing

The left side of the **Customize** window lists devices that can be tested. Devices are grouped by device type or by module, depending on the option you select. Click the **(+)** next to a device or module to view its components. Click the **(+)** on any component to view the tests that are available. Clicking a device, rather than its components, selects all of the components of the device for testing.

Selecting Diagnostics Options

Use the **Diagnostics Options** area to select how you want to test a device. You can set the following options:

- 1 **Non-Interactive Tests Only** — When checked, runs only the tests that require no user intervention.
- 1 **Quick Tests Only** — When checked, runs only the quick tests on the device. Extended tests do not run when you select this option.

Viewing Information and Results

The tabs in the **Customize** window provide information about the test and the test results. The following tabs are available:

- 1 **Results** — Displays the test that ran and the result.
- 1 **Errors** — Displays any errors that occurred during the test.
- 1 **Help** — Displays information about the currently selected device, component, or test.
- 1 **Configuration** — Displays basic configuration information about the currently selected device.
- 1 **Parameters** — If applicable, displays parameters that you can set for the test.

[Back to Contents Page](#)

[Back to Contents Page](#)

Troubleshooting Your System

Dell™ PowerEdge™ SC430 Systems Installation and Troubleshooting Guide

- [Safety First—For You and Your System](#)
- [Start-Up Routine](#)
- [Checking the Equipment](#)
- [Troubleshooting External Connections](#)
- [Troubleshooting Basic I/O Functions](#)
- [Troubleshooting a NIC](#)
- [Opening the System](#)
- [Closing the System](#)
- [Inside the System](#)
- [Troubleshooting a Wet System](#)
- [Troubleshooting a Damaged System](#)
- [Troubleshooting the System Battery](#)
- [Troubleshooting Power Supplies](#)
- [Troubleshooting System Cooling Problems](#)
- [Troubleshooting System Memory](#)
- [Troubleshooting a Diskette Drive](#)
- [Troubleshooting a CD Drive](#)
- [Troubleshooting an IDE Tape Drive](#)
- [Troubleshooting an Internal SCSI Tape Drive](#)
- [Troubleshooting SCSI Hard Drives](#)
- [Troubleshooting SATA Hard Drives](#)
- [Troubleshooting Expansion Cards](#)
- [Troubleshooting the Microprocessor](#)

Safety First—For You and Your System

To perform certain procedures in this document, you must remove the system cover and work inside the system. While working inside the system, do not attempt to service the system except as explained in this guide and elsewhere in your system documentation.

⚠ CAUTION: Only trained service technicians are authorized to remove the system cover and access any of the components inside the system. Before performing any procedure, see your *Product Information Guide* for complete information about safety precautions, working inside the computer and protecting against electrostatic discharge.

Start-Up Routine

Look and listen during the system's start-up routine for the indications described in [Table 4-1](#).

Table 4-1. Start-Up Routine Indications

Look/listen for:	Action
An error message displayed on the monitor.	See " System Messages " in "Indicators, Messages, and Codes."
A series of beeps emitted by the system.	See " System Beep Codes " in "Indicators, Messages, and Codes."
The monitor's power indicator.	See " Troubleshooting the Video Subsystem ."
The keyboard indicators.	See " Troubleshooting the Keyboard ."
The diskette drive (optional) activity indicator.	See " Troubleshooting a Diskette Drive ."
The CD drive activity indicator.	See " Troubleshooting a CD Drive ."
The hard-drive activity indicator.	See " Troubleshooting SCSI Hard Drives " or " Troubleshooting SATA Hard Drives ."
An unfamiliar constant scraping or grinding sound when you access a drive.	See " Getting Help ."

Checking the Equipment

This section provides troubleshooting procedures for external devices attached to the system, such as the monitor, keyboard, or mouse. Before you perform any of the procedures, see "[Troubleshooting External Connections](#)."

Troubleshooting IRQ Assignment Conflicts

Most PCI devices can share an IRQ with another device, but they cannot use an IRQ simultaneously. To avoid this type of conflict, see the documentation for each PCI device for specific IRQ requirements. [Table 4-2](#) lists the IRQ assignments.

Table 4-2. IRQ Assignment Defaults

IRQ Line	Assignment
IRQ0	System timer
IRQ1	Keyboard controller
IRQ2	Interrupt controller 1 to enable IRQ8 through IRQ15
IRQ3	Serial port 2 (COM2 and COM4)
IRQ4	Serial port 1 (COM1 and COM3)
IRQ5	Remote access controller
IRQ6	Diskette drive (optional) controller
IRQ8	Real-time clock
IRQ9	ACPI functions (used for power management)
IRQ10	<i>Available</i>
IRQ11	<i>Available</i>
IRQ13	Math coprocessor
IRQ14	IDE CD drive controller
IRQ15	<i>Available</i>

Troubleshooting External Connections

Loose or improperly connected cables are the most likely source of problems for the system, monitor, and other peripherals (such as a printer, keyboard, mouse, or other external device). Ensure that all external cables are securely attached to the external connectors on your system. See [Figure 2-1](#) for the front-panel connectors on your system and [Figure 2-2](#) for back-panel connectors.

Troubleshooting the Video Subsystem

Problem

1. Monitor is not working properly.

Action

1. Check the system and power connections to the monitor.
2. Run the appropriate online diagnostic test. See "[Using Server Administrator Diagnostics](#)" in "Running the System Diagnostics."

If the tests run successfully, the problem is not related to video hardware.

If the tests fail, see "[Getting Help](#)."

Troubleshooting the Keyboard

Problem

1. System message indicates a problem with the keyboard.
1. Keyboard is not functioning properly.

Action

1. Run the appropriate online diagnostic test. See "[Using Server Administrator Diagnostics](#)" in "Running the System Diagnostics."
2. Examine the keyboard and its cable for signs of damage.

3. Swap the faulty keyboard with a working keyboard.

If the problem is resolved, replace the faulty keyboard. See "[Getting Help](#)."

4. Enter the System Setup program and ensure that the USB ports are enabled. See "Using the System Setup Program" in your *User's Guide*.

If the problem is not resolved, see "[Getting Help](#)."

Troubleshooting the Mouse

Problem

1. System message indicates a problem with the mouse.
1. Mouse is not functioning properly.

Action

1. Run the appropriate online diagnostic test. See "[Using Server Administrator Diagnostics](#)" in "Running the System Diagnostics."

If the test fails, continue to the next step.

2. Examine the mouse and its cable for signs of damage.

If the mouse is not damaged, go to [step 4](#).

If the mouse is damaged, continue to the next step.

3. Swap the faulty mouse with a working mouse.

If the problem is resolved, replace the faulty mouse. See "[Getting Help](#)."

4. Enter the System Setup program and ensure that the USB ports are enabled. See "Using the System Setup Program" in your *User's Guide*.

If the problem is not resolved, see "[Getting Help](#)."

Troubleshooting Basic I/O Functions

Problem

1. Error message indicates a problem with a serial port.
1. Device connected to a serial port is not operating properly.

Action

1. Enter the System Setup program and ensure that the serial port(s) is enabled. See "Using the System Setup Program" in the *User's Guide*.

2. If the problem is confined to a particular application, see the application documentation for specific port configuration requirements that the program may require.

3. Run the appropriate online diagnostic test. See "[Using Server Administrator Diagnostics](#)" in "Running the System Diagnostics."

If the tests run successfully but the problem persists, see "[Getting Help](#)."

Troubleshooting a USB Device

Problem

1. System message indicates a problem with a USB device.

- 1 Device connected to a USB port is not operating properly.

Action

1. Enter the System Setup program, and ensure that the USB ports are enabled. See "Using the System Setup Program" in your *User's Guide*.
2. Turn off the system and any USB devices.
3. Disconnect the USB devices, and connect the malfunctioning device to the other USB connector.
4. Turn on the system and the reconnected device.

If the problem is resolved, the USB connector might be defective. See "[Getting Help](#)."

5. If possible, swap the interface cable with a working cable.

If the problem is resolved, replace the interface cable. See "[Getting Help](#)."

6. Turn off the system and the USB device, and swap the device with a comparable device.

7. Turn on the system and the USB device.

If the problem is resolved, replace the USB device. See "[Getting Help](#)."

If the problem persists, see "[Getting Help](#)."

Troubleshooting a NIC

Problem

- 1 NIC cannot communicate with network.

Action

1. Run the appropriate online diagnostic test. See "[Using Server Administrator Diagnostics](#)" in "Running the System Diagnostics."
2. Check the appropriate indicator on the NIC connector. See "[NIC Indicator Codes](#)" in "Indicators, Messages, and Codes."
 - 1 If the link indicator does not light, check all cable connections.
 - 1 If the activity indicator does not light, the network driver files might be damaged or missing. Ensure that the appropriate drivers are installed and the protocols are bound. See the NIC's documentation.

Remove and reinstall the drivers if applicable. See the NIC's documentation.
 - 1 Change the autonegotiation setting, if possible.
 - 1 Use another connector on the switch or hub.

If you are using a NIC card instead of an integrated NIC, see the documentation for the NIC card.

3. Enter the System Setup program and confirm that the NIC is enabled. See "Using the System Setup Program" in your *User's Guide*.
4. Ensure that the NICs, hubs, and switches on the network are all set to the same data transmission speed. See the network equipment documentation.
5. Ensure that all network cables are of the proper type and do not exceed the maximum length. See "[Network Cable Requirements](#)" in "I/O Connectors."

If the problem persists, see "[Getting Help](#)."

Opening the System

 **CAUTION:** Only trained service technicians are authorized to remove the system cover and access any of the components inside the system. Before performing any procedure, see your *Product Information Guide* for complete information about safety precautions, working inside the computer and protecting against electrostatic discharge.

1. Turn off the system and attached peripherals, and disconnect the system from the electrical outlet.
 2. Press the power button to ground the system board.
 3. If you have installed a padlock through the padlock ring on the back panel, remove the padlock.
 4. Lay the system on its side as shown in [Figure 4-1](#).
 5. Open the system by sliding the cover release tab toward the rear of the system and lifting the cover off.
-

Closing the System

1. Ensure that all internal cables are connected and folded out of the way.
2. Ensure that no tools or extra parts are left inside the system.
3. Reinstall the system cover:
 - a. Insert the bottom edge of the cover into the bottom of the system chassis. See [Figure 4-1](#).
 - b. Press down on the cover until the cover release tab snaps into place.
4. If applicable, install the padlock.
5. Reconnect the system to the electrical outlet, and turn on the system and attached peripherals.

After you open and close the cover, the chassis intrusion detector, if enabled, causes the following message to appear on the screen at the next system start-up:

ALERT! Cover was previously removed.

6. To reset the chassis intrusion detector, press <Enter>. See your *User's Guide* for details.

 **NOTE:** If a setup password has been assigned by someone else, contact your network administrator for information on resetting the chassis intrusion detector.

Figure 4-1. Opening and Closing the System



Inside the System

In [Figure 4-2](#), the system cover is opened to provide an interior view of the system.

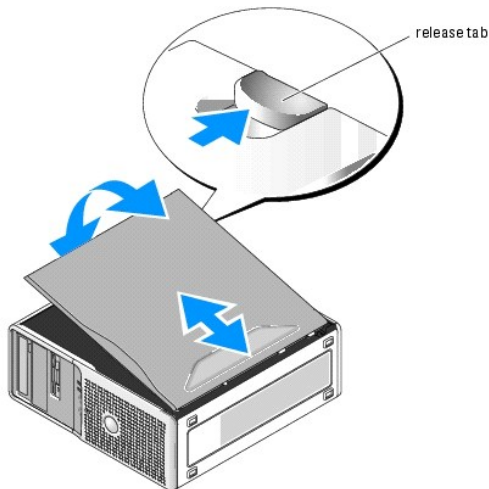
Figure 4-2. Inside the System

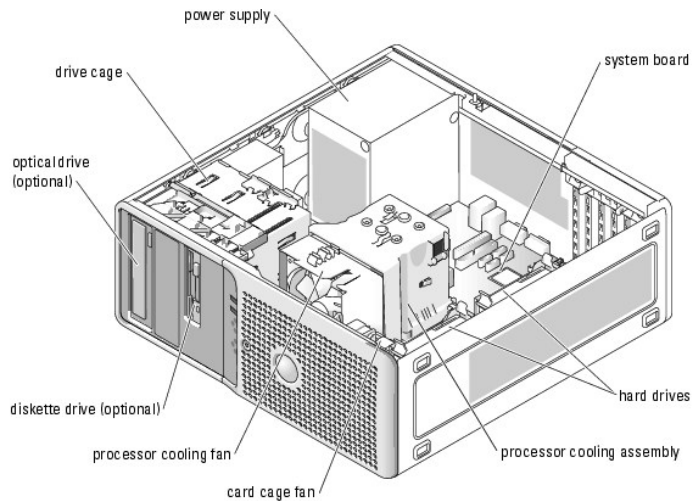

The system board can accommodate one processor, five expansion cards (two 5-V, half-length 32-bit, 33-MHz PCI, one 2.5-Gb/sec PCIe [x1], one 2.5-Gb/sec PCIe [x4], and one 2.5-Gb/sec PCIe [x8]), and four 533-MHz unbuffered ECC DDR II single or dual-rank memory modules.

The drive bays provide space for up to two 1-inch SATA hard drives with the integrated SATA controller or two SCSI hard drives. The SCSI hard drives must be connected to a controller card. They also provide space for an optional optical and diskette drive, or an optional tape backup unit (TBU). Power is supplied to the system board and internal peripherals through a single nonredundant power supply.

Removing and Replacing the Front Drive Bezel

CAUTION: Only trained service technicians are authorized to remove the system cover and access any of the components inside the system. Before performing any procedure, see your *Product Information Guide* for complete information about safety precautions, working inside the computer and protecting against electrostatic discharge.

1. Open the system. See "[Opening the System](#)."

NOTE: This sliding plate secures and releases the drive bezel and helps to secure the drives.

2. Pull the lever on the sliding plate to the right until it releases the front drive bezel from its side hinges.
3. Carefully tilt the front drive bezel away from the chassis and lift it out as shown in [Figure 4-3](#).
4. To replace the front drive bezel, reverse the steps above and snap the bezel into place.

Figure 4-3. Removing and Replacing the Front Drive Bezel

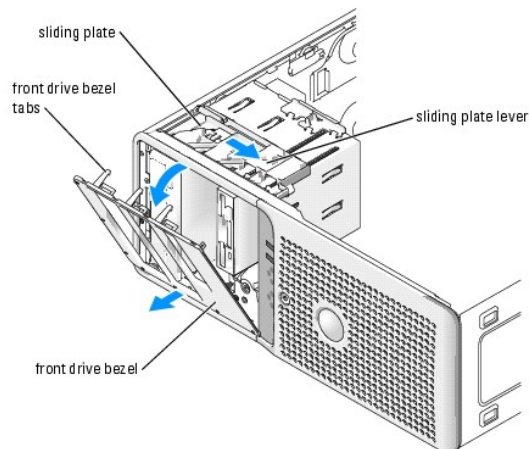

Removing and Replacing the Front Drive Bezel Insert

1. To remove the front drive bezel insert, press the two insert tabs on the front drive bezel inward and lift out the insert.
2. To replace the front drive bezel insert, reverse the step above and snap the insert into place.

Figure 4-4. Removing and Replacing the Front Drive Bezel Insert

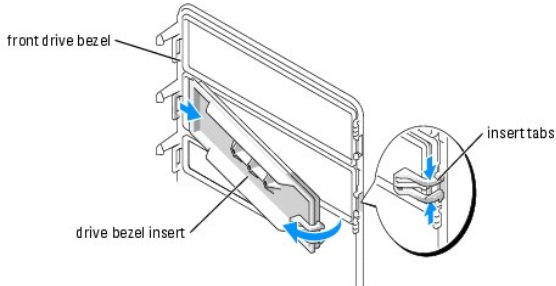

Troubleshooting a Wet System

Problem

1. Liquid spilled on the system.
1. Excessive humidity.

Action

⚠ CAUTION: Only trained service technicians are authorized to remove the system cover and access any of the components inside the system. Before performing any procedure, see your *Product Information Guide* for complete information about safety precautions, working inside the computer and protecting against electrostatic discharge.

1. Turn off the system and attached peripherals, and disconnect the system from the electrical outlet.
2. Open the system. See "[Opening the System](#)."
3. Remove all expansion cards installed in the system. See "[Removing an Expansion Card](#)" in "Installing System Options."
4. Let the system dry thoroughly for at least 24 hours.
5. Close the system. See "[Closing the System](#)."
6. Reconnect the system to the electrical outlet, and turn on the system and attached peripherals.
If the system does not start properly, see "[Getting Help](#)."
7. If the system starts properly, shut down the system and reinstall all of the expansion cards that you removed. See "[Installing an Expansion Card](#)" in "Installing System Options."
8. Run the appropriate online diagnostic test. See "[Using Server Administrator Diagnostics](#)" in "Running the System Diagnostics."
If the tests fail, see "[Getting Help](#)."

Troubleshooting a Damaged System

Problem

1. System was dropped or damaged.

Action

 **CAUTION:** Only trained service technicians are authorized to remove the system cover and access any of the components inside the system. Before performing any procedure, see your *Product Information Guide* for complete information about safety precautions, working inside the computer and protecting against electrostatic discharge.

1. Open the system. See "[Opening the System](#)."
2. Ensure that the following components are properly installed:
 - 1 Expansion cards
 - 1 Power supplies
 - 1 Fans
 - 1 Optional installed drives
 - 1 Processor heat sink
3. Ensure that all cables are properly connected.
4. Close the system. See "[Closing the System](#)."
5. Run the system board tests in the system diagnostics. See "[Running the System Diagnostics](#)."

If the tests fail, see "[Troubleshooting Your System](#)."

Troubleshooting the System Battery

Problem

- 1 System message indicates a problem with the battery.
- 1 System Setup program loses system configuration information.
- 1 System date and time do not remain current.

 **NOTE:** If the system is turned off for long periods of time (for weeks or months), the NVRAM may lose its system configuration information. This situation is caused by a defective battery.

A coin-cell battery maintains system configuration, date, and time information. The battery can last several years. If you have to repeatedly reset time and date information after turning on the system, or the following messages appear, replace the battery. See "[Replacing the Battery](#)" in "Installing System Options."

```
Time-of-day not set - please run SETUP program
```

or

```
Invalid configuration information -  
please run SETUP program
```

or

```
Battery voltage is low
```

You can operate your system without a battery; however, without a battery, the configuration information is erased if the system is turned off or unplugged from the electrical outlet. In this case, you must enter the System Setup program and reset the configuration options.

 **CAUTION:** A new battery can explode if it is incorrectly installed. Replace the battery only with the same or equivalent type recommended by the manufacturer. Discard used batteries according to the manufacturer's instructions.

Action

1. Re-enter the time and date through the System Setup program. See "Using the System Setup Program" in your *User's Guide*.
2. Turn off the system and disconnect it from the electrical outlet for at least one hour.
3. Reconnect the system to the electrical outlet and turn on the system.

4. Enter the System Setup program.

If the date and time are not correct in the System Setup program, replace the battery. See "[System Battery](#)" in "Installing System Options."

If the problem is not resolved by replacing the battery, see "[Getting Help](#)."

 **NOTE:** Some software may cause the system time to speed up or slow down. If the system seems to operate normally except for the time kept in the System Setup program, the problem may be caused by software rather than by a defective battery.

Troubleshooting Power Supplies

Problem

1. Power-supply fault indicator is blinking amber.

Action

 **CAUTION:** Only trained service technicians are authorized to remove the system cover and access any of the components inside the system. Before performing any procedure, see your *Product Information Guide* for complete information about safety precautions, working inside the computer and protecting against electrostatic discharge.

1. Turn off the system and attached peripherals, and disconnect the system from the electrical outlet.
2. Open the system. See "[Opening the System](#)."
3. Locate the AUX_PWR_LED power indicator on the system board. See [Figure A-3](#).

If the AUX_PWR_LED indicator is lit, the power supply is good. Proceed to the next step.

If the AUX_PWR_LED indicator is not lit, remove the faulty power supply and see "[Removing the Power Supply](#)" in "Installing System Options."

4. Check that the voltage selection switch on the back panel of the system is set properly. See "[Power Supply Features](#)" in "Indicators, Messages, and Codes."

 **NOTICE:** Setting the voltage selection switch to an improper setting can damage your system.

5. Ensure that the power supply is properly installed by removing and reinstalling it. See "[Installing the Power Supply](#)" in "Installing System Options."

 **NOTE:** After installing a power supply, allow several seconds for the system to recognize the power supply and to determine if it is working properly. The power indicator turns green to signify that the power supply is functioning properly.

6. If the problem is resolved, close the system. See "[Closing the System](#)."

If the problem persists, remove the faulty power supply. See "[Removing the Power Supply](#)" in "Installing System Options."

7. Install a new power supply. See "[Installing the Power Supply](#)" in "Installing System Options."

If the problem persists, see "[Getting Help](#)."

Troubleshooting System Cooling Problems

Problem

1. System message indicates a fan-related error message.

Action

Ensure that none of the following conditions exist:

1. Ambient temperature is too high. For system temperature tolerances, see the *User's Guide*.
1. External airflow is obstructed.

- 1 Cables inside the system obstruct airflow.
- 1 An individual cooling fan has failed. See "[Troubleshooting a Fan](#)."

Troubleshooting a Fan

Problem

- 1 System-status indicator is amber.
- 1 System message indicates a fan-related error message.

Action

 **CAUTION:** Only trained service technicians are authorized to remove the system cover and access any of the components inside the system. Before performing any procedure, see your *Product Information Guide* for complete information about safety precautions, working inside the computer and protecting against electrostatic discharge.

1. Run the appropriate diagnostic test. See "Using Server Administrator Diagnostics" in "Running System Diagnostics."
2. Open the system. See "[Opening the System](#)."
3. Ensure that the faulty fan's power cable is firmly attached to the fan power connector. See "[Cooling Fans](#)" in "Installing System Options."

 **NOTE:** Wait 30 seconds for the system to recognize the fan and determine whether it is working properly.

4. If the problem is not resolved, install a new fan. See "[Cooling Fans](#)" in "Installing System Options."

If the replacement fan is working properly, close the system. See "[Closing the System](#)."

If the replacement fan does not operate, see "[Getting Help](#)."

Troubleshooting System Memory

Problem

- 1 Faulty memory module.
- 1 Faulty system board.
- 1 Diagnostic indicators or system messages indicate a memory-related error.

Action

 **CAUTION:** Only trained service technicians are authorized to remove the system cover and access any of the components inside the system. Before performing any procedure, see your *Product Information Guide* for complete information about safety precautions, working inside the computer and protecting against electrostatic discharge.

1. Run the appropriate online diagnostic test. See "[Using Server Administrator Diagnostics](#)" in "Running the System Diagnostics."
2. Turn on the system and attached peripherals.
3. Enter the System Setup program and check the system memory setting. See "Using the System Setup Program" in your *User's Guide*.
4. Turn off the system and attached peripherals, and disconnect the system from the electrical outlet.
5. Open the system. See "[Opening the System](#)."
6. Ensure that the memory banks are populated correctly. See "[Memory Module Installation Guidelines](#)" in "Installing System Options."

If the memory modules are populated correctly, continue to the next step.

7. Reseat the memory modules in their sockets. See "[Installing a Memory Module](#)" in "Installing System Options."
8. Close the system. See "[Closing the System](#)."
9. Reconnect the system to the electrical outlet, and turn on the system and attached peripherals.
10. Enter the System Setup program and check the system memory setting. See "Using the System Setup Program" in your *User's Guide*.

If the amount of memory installed does not match the system memory setting, then perform the following steps:

- a. Turn off the system and attached peripherals, and disconnect the system from its electrical outlet.
- b. Open the system. See "[Opening the System](#)."

 **NOTE:** Several configurations for the memory modules exist; see "[Memory Module Installation Guidelines](#)" in "Installing System Options."

- c. Swap the memory modules in bank 1 with another bank of the same capacity. See "[Installing a Memory Module](#)" in "Installing System Options."
 - d. Close the system. See "[Closing the System](#)."
 - e. Reconnect the system to its electrical outlet, and turn on the system and attached peripherals.
 - f. As the system boots, observe the monitor screen and the diagnostic indicators on the front panel of the system.
11. Perform the following steps:
 - a. Turn off the system and attached peripherals, and disconnect the system from its electrical outlet.
 - b. Open the system. See "[Opening the System](#)."
 - c. Repeat [step c](#) through [step f](#) in [step 10](#) for each memory module installed.
- If the problem persists, see "[Getting Help](#)."

Troubleshooting a Diskette Drive

Problem

1. Diagnostic indicators or error messages indicate a diskette drive (optional) problem.

Action

 **CAUTION:** Only trained service technicians are authorized to remove the system cover and access any of the components inside the system. Before performing any procedure, see your *Product Information Guide* for complete information about safety precautions, working inside the computer and protecting against electrostatic discharge.

1. Enter the System Setup program and verify that the diskette drive is configured correctly. See "Using the System Setup Program" in the *User's Guide*.
2. Run the appropriate online diagnostic test. See "[Using Server Administrator Diagnostics](#)" in "Running the System Diagnostics."
3. Turn off the system and attached peripherals, and disconnect the system from the electrical outlet.
4. Open the system. See "[Opening the System](#)."
5. Ensure that the diskette drive interface cable is securely connected to the diskette drive and the system board.
6. Ensure that a power cable is properly connected to the drive.
7. Close the system. See "[Closing the System](#)."
8. Reconnect the system to the electrical outlet, and turn on the system and attached peripherals.
9. Run the appropriate online diagnostic test to see whether the diskette drive works correctly.

If the problem persists, continue with the following steps.

10. Turn off the system and attached peripherals, and disconnect the system from its electrical outlet.
11. Open the system. See "[Opening the System](#)."

12. Remove all expansion cards installed in the system. See "[Removing an Expansion Card](#)" in "Installing System Options."
 13. Close the system. See "[Closing the System](#)."
 14. Reconnect the system to the electrical outlet, and turn on the system and attached peripherals.
 15. Run the appropriate online diagnostic test to see whether the diskette drive works correctly.

If the tests run successfully, an expansion card may be conflicting with the diskette drive logic, or an expansion card may be faulty. Continue to the next step.

If the tests fail, see "[Getting Help](#)."
 16. Turn off the system and attached peripherals, and disconnect the system from the electrical outlet.
 17. Open the system. See "[Opening the System](#)."
 18. Reinstall one of the expansion cards you removed in [step 12](#). See "[Installing an Expansion Card](#)" in "Installing System Options."
 19. Close the system. See "[Closing the System](#)."
 20. Reconnect the system to the electrical outlet, and turn on the system and attached peripherals.
 21. Run the appropriate online diagnostic test to see whether the diskette drive works correctly.
 22. Repeat [step 16](#) through [step 21](#) until all expansion cards are reinstalled or one of the expansion cards causes the tests to fail.

If the problem is not resolved, see "[Getting Help](#)."
-

Troubleshooting a CD Drive

Problem

- 1 System cannot read data from a CD in an IDE CD drive.
- 1 Diagnostic indicators or system messages indicate a CD-related failure.
- 1 CD drive indicator, if applicable, does not blink during boot.
- 1 A **Recording** tab does not appear in the **Properties** window of your CD-R/RW drive, if applicable.
- 1 You cannot copy files to your CD-R/RW drive, if applicable.

 **NOTE:** If you are using a CD-R/RW drive with the Microsoft® Windows Server™ 2003 operating system, you must enable the operating system's native CD-R/RW recording capabilities. See "[Enabling the CD-R/RW Recording Feature in the Microsoft Windows Server 2003 Operating System](#)."

Action

 **CAUTION:** Only trained service technicians are authorized to remove the system cover and access any of the components inside the system. Before performing any procedure, see your *Product Information Guide* for complete information about safety precautions, working inside the computer and protecting against electrostatic discharge.

1. Try using a different CD that you know works properly.

If the problem persists, continue with the following steps.
2. Enter the System Setup program and ensure that the drive's IDE controller is enabled. See "Using the System Setup Program" in your *User's Guide*.
3. Run the appropriate online diagnostic test. See "[Using Server Administrator Diagnostics](#)" in "Running the System Diagnostics."
4. Turn off the system and attached peripherals, and disconnect the system from the electrical outlet.
5. Open the system. See "[Opening the System](#)."
6. Ensure that the CD interface cable is securely connected to the CD drive and to the controller.
7. Ensure that a power cable is properly connected to the drive.

8. Close the system. See "[Closing the System](#)."
 9. Reconnect the system to the electrical outlet, and turn on the system and attached peripherals.
- If the problem is not resolved, see "[Getting Help](#)."

Enabling the CD-R/RW Recording Feature in the Microsoft Windows Server 2003 Operating System

Although CD-R/RW recording is supported in Windows Server 2003, this feature is disabled by default.

To enable the CD-R/RW recording feature in Windows Server 2003, perform the following steps:

1. Click **Start**, click **Control Panel**, and then double-click **Administrative Tools**.
2. Double-click **Services**.
3. Right-click **IMAPI CD-Burning COM Service** and select **Properties**.
4. In the **Startup type** drop-down menu, select **Automatic**.
5. Click **Start** to start the service.
6. Click **OK** to close the window.
7. Reboot the system.
8. After the system the reboots, click **Start**→ **All Programs**→ **Accessories**→ **Windows Explorer**.
9. Right-click on your CD-R/RW drive icon and select **Properties**.
10. In the **CD Drive Properties** window, click the **Recording** tab.
11. Ensure that **Enable CD recording on this drive** is selected.
12. Click **OK** to close the window.

 **NOTE:** For more information on using the operating system's native CD-R/RW recording capabilities, see support.microsoft.com.

Troubleshooting an IDE Tape Drive

Problem

1. System cannot read data from a tape in an IDE tape drive.
1. Diagnostic indicators or system messages indicate a tape drive-related failure.
1. Tape drive indicator (if applicable) does not blink during boot.

Action

 **CAUTION:** Only trained service technicians are authorized to remove the system cover and access any of the components inside the system. Before performing any procedure, see your *Product Information Guide* for complete information about safety precautions, working inside the computer and protecting against electrostatic discharge.

1. Try using a different tape that you know works properly.
If the problem persists, continue with the following steps.
2. Enter the System Setup program and ensure that the drive's IDE controller is enabled. See "Using the System Setup Program" in your *User's Guide*.
3. Run the appropriate online diagnostic test. See "[Using Server Administrator Diagnostics](#)" in "Running the System Diagnostics."

4. Turn off the system and attached peripherals, and disconnect the system from the electrical outlet.
 5. Open the system. See "[Opening the System.](#)"
 6. Ensure that the IDE interface cable is securely connected to the tape drive and to the IDE connector on the system board.
 7. Ensure that a power cable is properly connected to the drive.
 8. Close the system. See "[Closing the System.](#)"
 9. Reconnect the system to the electrical outlet, and turn on the system and attached peripherals.
- If the problem is not resolved, see "[Getting Help.](#)"
-

Troubleshooting an Internal SCSI Tape Drive

Problem

- 1 Diagnostic indicators or system messages indicate a hard drive or expansion card problem
- 1 Defective tape drive.
- 1 Defective tape cartridge.
- 1 Missing or corrupted tape-backup software or tape drive device driver.
- 1 Defective SCSI controller.

Action

 **CAUTION:** Only trained service technicians are authorized to remove the system cover and access any of the components inside the system. Before performing any procedure, see your *Product Information Guide* for complete information about safety precautions, working inside the computer and protecting against electrostatic discharge.

1. Remove the tape cartridge that you were using when the problem occurred, and replace it with a tape cartridge that you know works.
 2. Ensure that the SCSI device drivers for the tape drive and the SCSI controller are installed and are configured correctly. See "[General Installation Guidelines](#)" in "Installing Drives."
 3. Reinstall the tape-backup software as instructed in the tape-backup software documentation.
 4. Verify that the tape drive is configured for a unique SCSI ID number and that the tape drive is terminated or not terminated, based on the interface cable used to connect the drive.

See the documentation for the tape drive for instructions on selecting the SCSI ID number and enabling or disabling termination.
 5. Run the appropriate online diagnostics tests. See "[Using Server Administrator Diagnostics](#)" in "Running the System Diagnostics."
 6. Turn off the system and attached peripherals, and disconnect the system from the electrical outlet.
 7. Open the system. See "[Opening the System.](#)"
 8. Ensure that the tape drive's interface and power cables are connected to the tape drive and SCSI controller card.
 9. Ensure that the SCSI controller card is firmly seated in its connector. See "[Installing an Expansion Card](#)" in "Installing System Options."
 10. Close the system. See "[Closing the System.](#)"
 11. Reconnect the system to the electrical outlet, and turn on the system, including attached peripherals.
 12. If the problem is not resolved, see the documentation for the tape drive for additional troubleshooting instructions.
 13. If you cannot resolve the problem, see "[Getting Help](#)" for information on obtaining technical assistance.
-

Troubleshooting SCSI Hard Drives

Problem

- 1 Diagnostic indicators or system messages indicate a hard drive or expansion card problem
- 1 Device driver error.
- 1 Hard drive not recognized by the system.

Action

 **CAUTION:** Only trained service technicians are authorized to remove the system cover and access any of the components inside the system. Before performing any procedure, see your *Product Information Guide* for complete information about safety precautions, working inside the computer and protecting against electrostatic discharge.

 **NOTICE:** This procedure can destroy data stored on the hard drive. Before you continue, back up all files on the hard drive.

1. Run the appropriate online diagnostic test. See "[Using Server Administrator Diagnostics](#)" in "Running the System Diagnostics."
For information about testing the SCSI controller, see the controller's documentation.
If the tests fail, continue to the next step.
2. Restart the system and enter the SCSI configuration utility.
 **NOTE:** To enter the utility, press <Ctrl><a> or <Ctrl><m>, depending on the utility. See the documentation supplied with the controller for information about the configuration utility.
3. Ensure that the primary SCSI channel is properly configured and restart the system. Use the SCSI controller documentation.
4. Ensure that the required device drivers are installed and configured correctly.
5. Turn off the system and attached peripherals, and disconnect the system from the electrical outlet.
6. Open the system. See "[Opening the System](#)."
7. Ensure that the hard-drive interface cable is properly connected between the drive and the system board or controller card. See the documentation supplied with the controller card.
8. If the hard drive is the boot drive, ensure that the drive is configured and connected properly. See "[Configuring the Boot Device](#)" in "Installing Drives."
9. Ensure that a power cable is properly connected to the drive.
10. Ensure that the hard drive is configured with a unique SCSI ID number and that the drive is terminated or not terminated as appropriate. See the documentation for the hard drive.
11. Close the system. See "[Closing the System](#)."
12. Reconnect the system to the electrical outlet, and turn on the system and attached peripherals.
If the problem persists, continue to the next step.
13. Format and partition the hard drive. See the operating system documentation.
14. If possible, restore the files to the drive.
If the problem persists, see "[Getting Help](#)."

Troubleshooting SATA Hard Drives

Problem

- 1 Diagnostic indicators or system messages indicate a hard drive-related failure.
- 1 Faulty hard drive.

- 1 Damaged or improperly connected hard-drive cables.

Action

 **CAUTION:** Only trained service technicians are authorized to remove the system cover and access any of the components inside the system. Before performing any procedure, see your *Product Information Guide* for complete information about safety precautions, working inside the computer and protecting against electrostatic discharge.

 **NOTICE:** This troubleshooting procedure can destroy data stored on the hard drive. Before you proceed, back up all files on the hard drive.

1. Run the appropriate online diagnostic test. See "[Using Server Administrator Diagnostics](#)" in "Running the System Diagnostics."
2. Enter the System Setup program and verify that the system is configured correctly. See "Using the System Setup Program" in your *User's Guide*.
3. Turn off the system and attached peripherals, and disconnect the system from the electrical outlet.
4. Open the system. See "[Opening the System](#)."
5. Ensure that the hard-drive interface cable is properly connected between the drive and the system board.
To identify system board connectors, see [Figure A-3](#).
6. If the hard drive is the boot drive, ensure that the drive is configured and connected properly. See "[Configuring the Boot Device](#)" in "Installing Drives."
7. Ensure that the power cable is properly connected to the drive.
8. Close the system. See "[Closing the System](#)."
9. Reconnect the system to the electrical outlet, and turn on the system and attached peripherals.
10. Format and partition the hard drive. See the operating system documentation.
11. If possible, restore the files to the drive.
If the problem persists, see "[Getting Help](#)."

Troubleshooting Expansion Cards

 **NOTE:** When troubleshooting an expansion card, see the documentation for your operating system and the expansion card.

Problem

- 1 Error message indicates a problem with an expansion card.
- 1 Expansion card performs incorrectly or not at all.

Action

 **CAUTION:** Only trained service technicians are authorized to remove the system cover and access any of the components inside the system. Before performing any procedure, see your *Product Information Guide* for complete information about safety precautions, working inside the computer and protecting against electrostatic discharge.

1. Run the appropriate online diagnostic test. See "[Using Server Administrator Diagnostics](#)" in "Running the System Diagnostics."
2. Turn off the system and attached peripherals, and disconnect the system from the electrical outlet.
3. Open the system. See "[Opening the System](#)."
4. Ensure that each expansion card is firmly seated in its connector. See "Installing an Expansion Card" in "Installing System Options."
5. Close the system. See "[Closing the System](#)."
6. Reconnect the system to the electrical outlet, and turn on the system and attached peripherals.

If the problem persists, go to the next step.

7. Turn off the system and attached peripherals, and disconnect the system from the electrical outlet.
8. Open the system. See "[Opening the System](#)."
9. Remove all expansion cards installed in the system. See "[Removing an Expansion Card](#)" in "Installing System Options."
10. Close the system. See "[Closing the System](#)."
11. Reconnect the system to the electrical outlet, and turn on the system and attached peripherals.
12. Run the appropriate online diagnostic test.

If the tests fail, see "[Getting Help](#)."

13. For each expansion card you removed in [step 9](#), perform the following steps:
 - a. Turn off the system and attached peripherals, and disconnect the system from the electrical outlet.
 - b. Open the system. See "[Opening the System](#)."
 - c. Reinstall one of the expansion cards.
 - d. Close the system. See "[Closing the System](#)."
 - e. Run the appropriate diagnostic test.

If the tests fail, see "[Getting Help](#)."

Troubleshooting the Microprocessor

Problem

1. Error message indicates a microprocessor problem.
1. A heat sink is not installed for the processor.

Action

 **CAUTION:** Only trained service technicians are authorized to remove the system cover and access any of the components inside the system. Before performing any procedure, see your *Product Information Guide* for complete information about safety precautions, working inside the computer and protecting against electrostatic discharge.

1. Run the appropriate online diagnostics test. See "[Using Server Administrator Diagnostics](#)" in "Running the System Diagnostics."
2. Turn off the system and attached peripherals, and disconnect the system from the electrical outlet.
3. Open the system. See "[Opening the System](#)."
4. Ensure that the processor and heat sink assembly are properly installed. See "[Removing the Processor](#)" in "Installing System Options."
5. Close the system. See "[Closing the System](#)."
6. Reconnect the system to the electrical outlet, and turn on the system and attached peripherals.

If the problem persists, see "[Getting Help](#)."

[Back to Contents Page](#)

Installing System Options

Dell™ PowerEdge™ SC430 Systems Installation and Troubleshooting Guide

- [Memory](#)
- [Microprocessor](#)
- [Expansion Cards](#)
- [Power Supply](#)
- [Cooling Fans](#)
- [System Battery](#)

Memory

The four memory module connectors on the system board can accommodate from 256 MB to 4 GB of 533-MHz unbuffered ECC DDR II single or dual-rank memory modules. See [Figure A-3](#) for the location of the four memory module connectors.

 **NOTE:** As shown in [Figure A-3](#), memory slots are not in numeric order on the system board. When installing memory, take care to install it in the proper slots according to the configuration guidelines in [Table 5-1](#). Installing memory in the wrong slots will significantly reduce system performance.

Memory Module Upgrade Kits

The system is upgradable to 4 GB by installing combinations of 256-MB, 512-MB, or 1-GB 533-MHz unbuffered ECC DDR II single or dual-rank memory modules. You can purchase memory upgrade kits from Dell.

Memory Module Installation Guidelines

- 1 If only one memory module is installed, it must be installed in connector DIMM_1.
- 1 If only one memory module is installed in connector DIMM_1, its capacity must be 256 MB.
- 1 If more than one memory module is installed, the memory modules must be installed in *pairs of matched memory size, speed, and technology*.
- 1 Memory modules must be installed in ordered pairs in connectors DIMM_1 and DIMM_2, and then DIMM_3 and DIMM_4.
- 1 If a processor with a slower front-side bus rating than the memory is installed, the memory will operate at the processor's slower front-side bus speed.

 **NOTE:** If you remove your original memory modules from the system during a memory upgrade, keep them separate from any new memory modules that you may have, even if you purchased the new memory modules from Dell. Use only unregistered or unbuffered ECC DDR II memory modules.

[Table 5-1](#) illustrates memory configuration guidelines. It is important to follow the slot installation configurations shown here to achieve maximum memory performance.

Table 5-1. Memory Configuration Guidelines

Total Memory	DIMM_1	DIMM_2	DIMM_3	DIMM_4
256 MB	256 MB	none	none	none
512 MB	256 MB	256 MB	none	none
1 GB	256 MB	256 MB	256 MB	256 MB
1 GB	512 MB	512 MB	none	none
1.5 GB	256 MB	256 MB	512 MB	512 MB
2 GB	512 MB	512 MB	512 MB	512 MB
2 GB	1 GB	1 GB	none	none
3 GB	1 GB	1 GB	512 MB	512 MB
4 GB	1 GB	1 GB	1 GB	1 GB

Addressing Memory With 4-GB Configurations (Microsoft® Windows® Operating System Only)

Your system supports a maximum of 4 GB of memory using four 1-GB memory modules. Current operating systems can use a maximum of 4 GB of address space; however, the amount of memory available to the operating system is slightly less than 4 GB.

 **NOTE:** Depending on the type of PCI/PCIe expansion cards that are installed in your system, your system may only support a maximum of 3.4 GB of memory or less.

The following components require address space:

- 1 System ROM
- 1 Advanced Programmable Interrupt Controllers (APIC)
- 1 Integrated PCI devices (such as NICs) and SCSI controllers
- 1 PCI expansion cards

At start-up, the BIOS identifies the components that require address space. The BIOS dynamically calculates the amount of reserved address space required. The BIOS then subtracts the reserved address space from 4 GB to determine the amount of usable space.

- 1 If the total installed system memory is less than the usable space, all installed system memory is available for use only by the operating system.
- 1 If the total installed system memory is equal to or greater than the usable address space, a small portion of installed memory is available for use by the operating system.

Installing a Memory Module

⚠ CAUTION: Only trained service technicians are authorized to remove the system cover and access any of the components inside the system. Before performing any procedure, see your *Product Information Guide* for complete information about safety precautions, working inside the computer and protecting against electrostatic discharge.

1. Turn off the system and attached peripherals, and disconnect the system from the electrical outlet.
2. Open the system. See "[Opening the System](#)" in "Troubleshooting Your System."
3. Press on the securing clip at each end of the memory module connector. See [Figure 5-1](#).
4. Align the memory module's edge connector with the alignment key in the connector.

The memory module connector has an alignment key that allows the memory module to be installed in the connector in only one way.

5. Applying even pressure to both ends of the module, insert the module into the connector and carefully press the module into place.

Figure 5-1. Installing a Memory Module

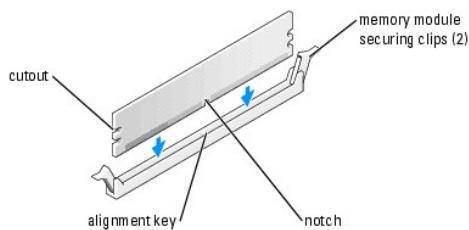

6. Pull up on the securing clips to lock the module into place.

If you insert the module correctly, the securing clips snap into the cutouts at each end of the module.

When the memory module is properly seated in the connector, the securing clips on the memory module socket should align with the securing clips on the other connectors with memory modules installed.

7. Close the system. See "[Closing the System](#)" in "Troubleshooting Your System."
8. Reconnect the system to the electrical outlet, and turn on the system and attached peripherals.

The system detects that the new memory does not match the existing configuration information and generates the following message:

```
The amount of system memory has changed.
Strike the F1 key to continue, F2 to run the setup utility
```

9. Press <F2> to enter the System Setup program and check the value for **Memory Info**. See your *User's Guide* for detailed information.

The system should have changed the value for **Memory Info** to reflect the newly installed memory. Verify the new value. If it is correct, skip to [step 13](#).
10. If the memory value is incorrect, turn off the system and attached peripherals, and disconnect the system from the electrical outlet.
11. Open the system. See "[Opening the System](#)" in "Troubleshooting Your System."
12. Ensure that the installed memory modules are seated properly in their connectors, and repeat [step 6](#) through [step 9](#).

13. When the **Memory Info** value is correct, press <Esc> to exit the System Setup program.
14. Run the system diagnostics to verify that the memory modules are operating properly.

Removing a Memory Module

⚠ CAUTION: Only trained service technicians are authorized to remove the system cover and access any of the components inside the system. Before performing any procedure, see your *Product Information Guide* for complete information about safety precautions, working inside the computer and protecting against electrostatic discharge.

1. Turn off the system and attached peripherals, and disconnect the system from the electrical outlet.
2. Open the system. See "[Opening the System](#)" in "Troubleshooting Your System."
3. Press out on the securing clip at each end of the memory module connector. See [Figure 5-1](#).
4. Grasp the memory module and pull it out of the connector.

If the module is difficult to remove, gently move the module back and forth to remove it from the connector.

Microprocessor

To take advantage of future options in speed and functionality, you can upgrade the processor.

The processor and its associated cache memory are contained in a Land Grid Array (LGA) package that is installed in a socket on the system board.

Removing the Processor

⚠ CAUTION: Only trained service technicians are authorized to remove the system cover and access any of the components inside the system. Before performing any procedure, see your *Product Information Guide* for complete information about safety precautions, working inside the computer and protecting against electrostatic discharge.

⚠ CAUTION: The processor and heat sink can get very hot during normal operation. Ensure that they have had sufficient time to cool before you touch them.

1. Turn off the system and attached peripherals, and disconnect the system from the electrical outlet.
2. Open the system. See "[Opening the System](#)" in "Troubleshooting Your System."
3. Loosen the two captive screws holding the processor cooling shroud and heat sink in place.
These captive screws are adjacent to the processor cooling fan housing. See [Figure 5-2](#).
4. Tilt the processor cooling shroud away from the fan housing and lift it out.

Figure 5-2. Removing the Processor Cooling Assembly

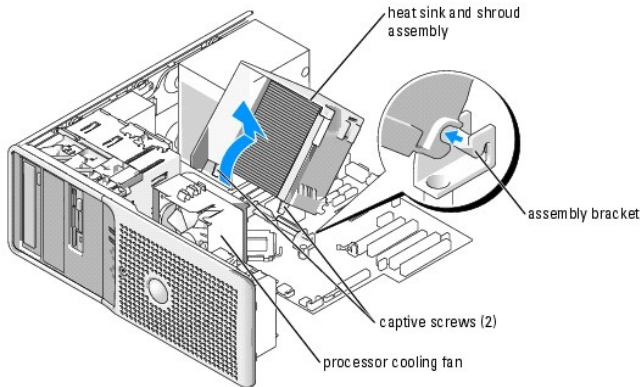

5. Open the processor cover by sliding the release lever from under the release level latch on the socket. Then, pull the lever back to release the processor. See [Figure 5-3](#).

Figure 5-3. Removing the Processor

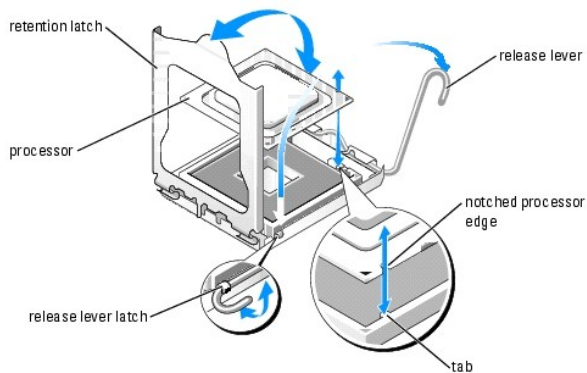

➡ **NOTICE:** The retention latch is pressure-loaded. Ensure that the latch does not quickly open and strike the processor or system board.

6. Carefully pivot the retention latch away from the processor.

➡ **NOTICE:** Do not pry the processor from the socket by a single edge. This could result in damage to the processor's delicate connections.

➡ **NOTICE:** Be careful not to touch or drop any foreign materials on the socket connector pads.

7. Lift the processor straight up and out of the socket.

Leave the release lever and retention latch in the release position so that the socket is ready for the new processor.

Replacing the Processor

1. Ensure that the contacts on the bottom of the replacement processor are free from dirt or other foreign material.

2. Align the notched edge of the replacement processor with the tab on the processor frame. See [Figure 5-3](#).

➡ **NOTICE:** Use caution when removing and installing the processor. Damaging the processor socket connectors can damage the system board.

3. Carefully set the processor in the processor frame. Ensure that the notched edge of the processor fits securely over the matching tab on the processor frame. Do not press down on the processor. If the processor is seated correctly, it should fit snugly in the socket frame. See [Figure 5-3](#).

4. Lower the retention latch onto the processor, and then rotate the release lever latch back toward the system board until it snaps into place.

5. Clean the thermal grease from the bottom of the heat sink.

➡ **NOTICE:** Ensure that you apply new thermal grease. Applying new thermal grease is critical to ensuring proper thermal bonding as well as optimal processor operation.

6. Apply new thermal grease to the top of the processor.
7. Place the heat sink assembly back onto the heat sink assembly bracket and tilt the heat sink assembly down on the system board. See [Figure 5-2](#).
8. Align the two capture screws properly with the system board, then tighten them to secure the heat sink assembly to the system board.
9. Close the system. See "[Closing the System](#)" in "Troubleshooting Your System."
10. Reconnect the system to the electrical outlet, and turn on the system and attached peripherals.

Expansion Cards

The system board can accommodate five expansion cards (two 5-V, half-length 32-bit, 33-MHz PCI, one 2.5-Gb/sec PCIe [x1], one 2.5-Gb/sec PCIe [x4], and one 2.5-Gb/sec PCIe [x8]). See [Figure A-3](#) for the location of the expansion card slots.

🚫 **NOTE:** The PCI slots do not support 3.3-V expansion cards. Only 5-V PCI expansion cards are supported.

Installing an Expansion Card

⚠️ **CAUTION:** Only trained service technicians are authorized to remove the system cover and access any of the components inside the system. Before performing any procedure, see your *Product Information Guide* for complete information about safety precautions, working inside the computer and protecting against electrostatic discharge.

1. Turn off the system and attached peripherals, and disconnect the system from the electrical outlet.
2. Open the system. See "[Opening the System](#)" in "Troubleshooting Your System."
3. Press the two release tabs on the card retention door inward to open it. See [Figure 5-4](#).

Figure 5-4. Installing an Expansion Card

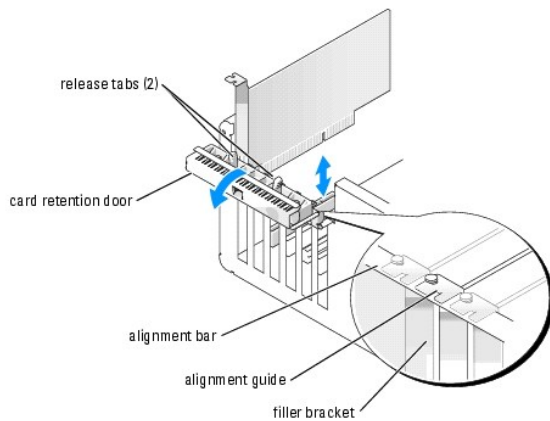

4. If you are installing a new card, remove the filler bracket.

🚫 **NOTE:** Keep this bracket in case you need to remove the expansion card. Filler brackets must be installed over empty expansion-card slots to maintain Federal Communications Commission (FCC) certification of the system. The brackets also keep dust and dirt out of the system and aid in proper cooling and airflow inside the system.

5. Prepare the card for installation.

See the documentation that came with the card for information on configuring the card, making internal connections, or otherwise customizing it for your system.

🚫 **NOTE:** Some NICs automatically start the system when they are connected to a network.

6. Place the card-edge connector in the expansion-card connector and press down firmly. Ensure that the card is fully seated in the slot and all cards and filler brackets are flush with the alignment bar.
7. Close the card retention door to secure the card(s) in the system.

 **NOTICE:** Do not route card cables over or behind the cards. Cables routed over the cards can prevent the system cover from closing properly or cause damage to the equipment.

8. Connect any cables that should be attached to the card.
See the documentation for the card for information about the card's cable connections.
9. Close the system. See "[Closing the System](#)" in "Troubleshooting Your System."
10. Reconnect the system to the electrical outlet, and turn on the system and attached peripherals.
11. Install any device drivers required for the card as described in the documentation for the card.

Removing an Expansion Card

 **CAUTION:** Only trained service technicians are authorized to remove the system cover and access any of the components inside the system. Before performing any procedure, see your *Product Information Guide* for complete information about safety precautions, working inside the computer and protecting against electrostatic discharge.

1. Turn off the system and attached peripherals, and disconnect the system from the electrical outlet.
2. Open the system. See "[Opening the System](#)" in "Troubleshooting Your System."
3. Press the two release tabs on the card retention door inward to open it. See [Figure 5-4](#).
4. If necessary, disconnect any cables from the card.
5. Grasp the card by its top corners and ease it out of its connector.
6. If you are removing the card permanently, install a filler bracket in the empty card-slot opening.

 **NOTE:** Filler brackets must be installed over empty expansion card slots to maintain FCC certification of the system. The brackets also keep dust and dirt out of the system and aid in proper cooling and airflow inside the system.

7. Close the card retention door to secure the remaining card(s) in the system. See [Figure 5-4](#).
 8. Close the system. See "[Closing the System](#)" in "Troubleshooting Your System."
 9. Reconnect the system to the electrical outlet, and turn on the system and attached peripherals.
 10. Remove the card's device driver from the operating system.
-

Power Supply

Removing the Power Supply

 **CAUTION:** Only trained service technicians are authorized to remove the system cover and access any of the components inside the system. Before performing any procedure, see your *Product Information Guide* for complete information about safety precautions, working inside the computer and protecting against electrostatic discharge.

1. Turn off the system and attached peripherals, and disconnect the system from the electrical outlet.
2. Open the system. See "[Opening the System](#)."
3. Remove the heat sink and shroud assembly. See "[Removing the Processor](#)."

4. Disconnect the following power-supply cables:
 - 1 P1 and P2 connector to the system board
 - 1 P3 and P5 connectors to the SATA drives (if applicable)
 - 1 P11 connector to the SCSI drives (if applicable)
 - 1 P7 connector to the diskette drive (if applicable)
 - 1 P8 and P9 connectors to the optical and tape drives (if applicable)

 **NOTE:** Note the routing of the DC power cables underneath the tabs in the system frame as you release the tabs and remove the cables from the system board and drives. You must route these cables properly when you replace them to prevent their being pinched or crimped.

5. Remove the IDE, I/O panel, and SATA cables attached to the routing clamps on the side of the power supply.
6. Using a #2 Phillips screwdriver, remove the four Phillips screws that secure the power supply to the back panel.
7. Press the power-supply release tab down and slide the power supply toward the front of the system, then lift it out of the system chassis. See [Figure 5-5](#).

Figure 5-5. Removing the Power Supply and Cooling Fan

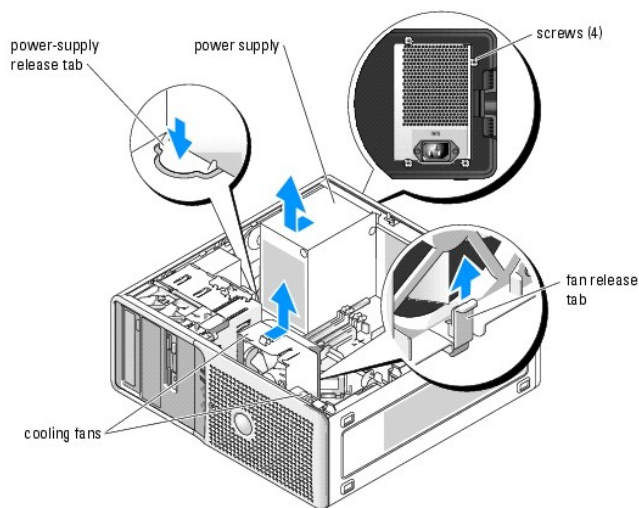

Installing the Power Supply

1. Prepare the new power supply for installation.
 2. Align the power supply mounting holes with the mounting holes on the back panel.
 3. Slide the power supply toward the back panel until it snaps into place over the power-supply release tab.
 4. Using a #2 Phillips screwdriver, install the four Phillips screws that secure the power supply to the back panel.
 5. Reconnect the following power-supply cables:
 - 1 P1 and P2 connector to the system board
 - 1 P3 and P5 connectors to the SATA drives (if applicable)
 - 1 P11 connector to the SCSI drives (if applicable)
 - 1 P7 connector to the diskette drive (if applicable)
 - 1 P8 and P9 connectors to the optical and tape drives (if applicable)
 6. Reinstall the heat sink and shroud assembly. See "[Replacing the Processor](#)."
 7. Close the system. See "[Closing the System](#)" in "Troubleshooting Your System."
-

Cooling Fans

The system contains two cooling fans, one for the processor and one for the card cage. Each contains a shroud that is part of the cooling fan assembly. The fan and shroud are replaced as a unit.

 **NOTE:** If you are removing the larger processor cooling fan, you must first remove the processor heat sink and shroud assembly. See "[Removing the Processor](#)" and [Figure 5-2](#).

Replacing the Cooling Fans

 **CAUTION:** Only trained service technicians are authorized to remove the system cover and access any of the components inside the system. Before performing any procedure, see your *Product Information Guide* for complete information about safety precautions, working inside the computer and protecting against electrostatic discharge.

1. Turn off the system and attached peripherals, and disconnect the system from the electrical outlet.
 2. Open the system. See "[Opening the System](#)" in "Troubleshooting Your System."
 3. Disconnect the fan's power cable from the system board. See [Figure A-3](#).
 4. Depending on which fan you are removing:
 - a. If you are removing the smaller card cage fan, press the single release tab that attaches the fan to the chassis and slide the fan toward the back panel. The fan can then be lifted out.
 - b. If you are removing the larger processor cooling fan, you must first remove the processor heat sink and shroud assembly. See "[Removing the Processor](#)." Once the heat sink and shroud assembly are removed, press the release tab that attaches the processor cooling fan to the chassis and slide the fan toward the back panel. The fan can then be lifted out.
 5. Align the securing tabs on the replacement fan with the mounting holes in the system chassis.
 6. Slide the fan toward the front panel until it snaps into place.
 7. If you replaced the larger processor cooling fan, replace the processor heat sink and shroud. See "[Replacing the Processor](#)."
 8. Reconnect the fan power cables to the system board.
 9. Close the system. See "[Closing the System](#)" in "Troubleshooting Your System."
-

System Battery

A coin-cell battery maintains system configuration, date, and time information. The battery can last several years.

To determine whether you need to replace the battery, see "[Troubleshooting the System Battery](#)" in "Troubleshooting Your System."

You can operate your system without a battery; however, without a battery, the configuration information is erased if the system is turned off or unplugged from the electrical outlet. In this case, you must enter the System Setup program and reset the configuration options.

 **CAUTION:** A new battery can explode if it is incorrectly installed. Replace the battery only with the same or equivalent type recommended by the manufacturer. Discard used batteries according to the manufacturer's instructions.

Replacing the Battery

 **CAUTION:** Only trained service technicians are authorized to remove the system cover and access any of the components inside the system. Before performing any procedure, see your *Product Information Guide* for complete information about safety precautions, working inside the computer and protecting against electrostatic discharge.

1. Enter the System Setup program and write down your setup settings. See "Using the System Setup Program" in your *User's Guide*.
 2. Turn off the system and attached peripherals, and disconnect the system from the electrical outlet.
 3. Open the system. See "[Opening the System](#)" in "Troubleshooting Your System."
 4. Locate the battery on the system board. See [Figure A-3](#) for the battery location.
-  **NOTE:** If you use a blunt, nonconductive object to depress the tab next to the battery, be careful not to touch the system board with the object. Ensure that the object is inserted between the battery and the tab before you attempt to depress the tab. Do not pry out the battery. You may damage the system board by prying off the socket or by breaking circuit traces on the system board.

5. Remove the battery by pressing on the tab. See [Figure 5-6](#).

Figure 5-6. Replacing the Battery

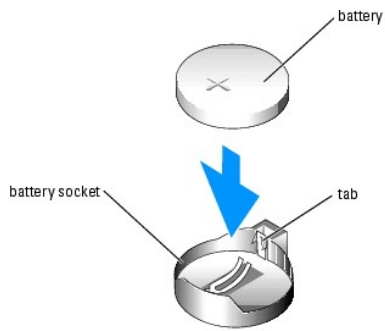

6. Install the new battery with the side labeled "+" facing up, and press down until it snaps into place.
7. Close the system. See "[Closing the System](#)" in "Troubleshooting Your System."
8. Reconnect the system to the electrical outlet, and turn on the system and attached peripherals.
9. Enter the System Setup program to confirm that the battery operates properly.
10. From the main screen, select **System Time** to enter the correct time and date.
Also, re-enter any system configuration information that is no longer displayed on the System Setup screens, and then exit the System Setup program.
11. To test the newly installed battery, turn off the system and disconnect it from electrical power for at least an hour.
12. After an hour, reconnect the system to a power source and turn it on.
13. Enter the System Setup program. If the time and date are still incorrect, see "[Getting Help](#)."
14. Properly dispose of the old battery. For more information, see your *Product Information Guide*.

[Back to Contents Page](#)

[Back to Contents Page](#)

Installing Drives

Dell™ PowerEdge™ SC430 Systems Installation and Troubleshooting Guide

- [General Installation Guidelines](#)
- [Installing SATA or SCSI Hard Drives](#)
- [Installing a SCSI Controller Card](#)
- [Installing a Diskette Drive](#)
- [Installing 5.25-Inch Optical and Tape Drives](#)

The drive bays in your system provide space for up to two SATA or SCSI hard drives, two 5.25-inch drives, and one optional diskette drive. See [Figure 6-1](#).

Figure 6-1. Drive Locations Inside the System

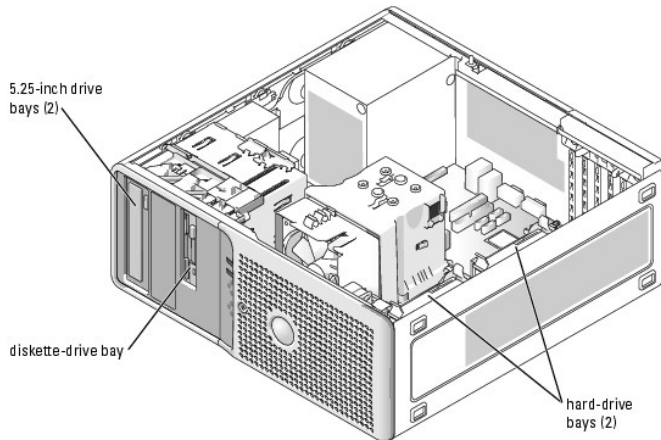

General Installation Guidelines

SCSI Installation Guidelines

Although SCSI drives are installed in essentially the same way as other drives, their configuration requirements are different. To install and configure a SCSI drive, follow the guidelines in the following subsections.

- **NOTE:** The SCSI controller card must be installed in PCI slot 3 or slot 5. See [Figure A-3](#).
- **NOTE:** SCSI devices installed by Dell are configured correctly during the manufacturing process. You do not need to set the SCSI ID for these drives.

SCSI Interface Cables

SCSI interface connectors are keyed for correct insertion. Keying ensures that the pin-1 wire in the cable connects to pin 1 in the connectors on both ends. When you disconnect an interface cable, ensure that you grasp the cable connector, rather than the cable itself, to avoid stress on the cable.

SCSI ID Numbers

Each drive attached to a SCSI controller must have a unique SCSI ID number from 0 to 15.

- 1 The SCSI hard drive from which the system boots is configured as SCSI ID 0.
- 1 If you install an additional SCSI drive or change your SCSI configuration, see the documentation for each SCSI drive for information on setting the appropriate SCSI ID number.

- **NOTE:** There is no requirement that SCSI ID numbers be assigned sequentially or that drives be attached to the interface cable in order by ID number.

SCSI Device Termination

SCSI logic requires that termination be enabled for the two drives at opposite ends of the SCSI chain and disabled for all drives in between. For internal SCSI drives, termination is configured automatically. See the documentation provided with any optional SCSI drive you purchase for information on disabling termination.

Configuring the Boot Device

The drive or device from which the system boots is determined by the boot order specified in the System Setup program. See "Using the System Setup Program" in your *User's Guide*. To boot the system from a hard drive or drive array, the drive(s) must be connected to the appropriate controller:

To boot from a SCSI hard drive, the drive must be connected to the optional SCSI controller card. See the documentation that accompanied the controller card.

The system can also boot from an external USB diskette or optical drive. See "Using the System Setup Program" in your *User's Guide*.

Installing SATA or SCSI Hard Drives

Your system contains up to two SATA or SCSI non-hot-plug hard drives. The integrated SATA controller supports two SATA hard drives. If your system contains SCSI hard drives, they must be connected to an optional SCSI controller card.

The steps for removing and installing SATA and SCSI hard drives are the same.

Removing a Hard Drive

⚠ CAUTION: Only trained service technicians are authorized to remove the system cover and access any of the components inside the system. Before performing any procedure, see your *Product Information Guide* for complete information about safety precautions, working inside the system and protecting against electrostatic discharge.

1. Turn off the system and attached peripherals, and disconnect the system from the electrical outlet.
2. Open the system. See "[Opening the System](#)" in "Troubleshooting Your System."
3. Disconnect the power and interface cables from the hard drive. See [Figure 6-2](#) and [Figure 6-3](#).

Figure 6-2. Removing or Installing a SCSI Hard Drive

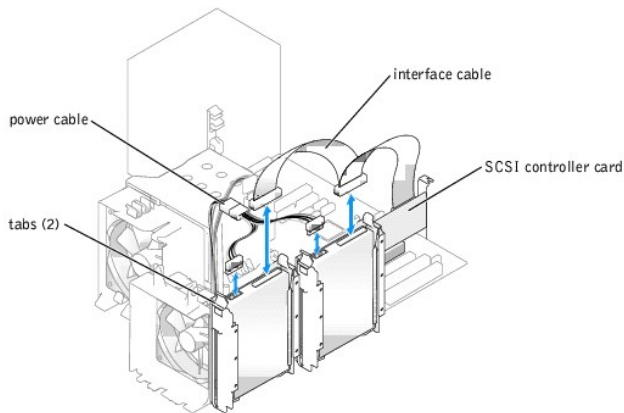
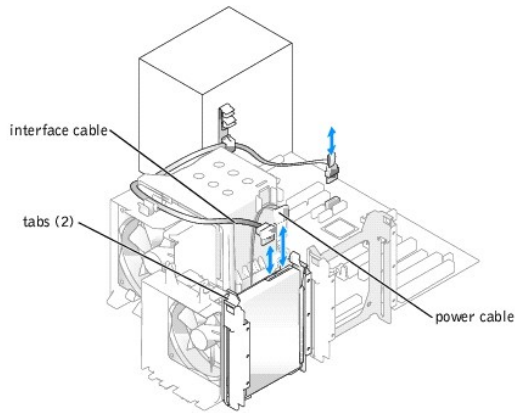

Figure 6-3. Removing or Installing a SATA Hard Drive



4. Press in the tabs on each side of the removable drive guide bracket and slide the guide bracket up and out of the drive bay.

NOTE: If you do not intend to replace the drive, it is highly recommended that you remove the drive from the guide bracket (see [Figure 6-4](#)) and insert the empty guide bracket back into the drive bay. This eliminates the likelihood that the empty bracket will be misplaced or improperly stored while not in use.

5. Close the system. See "[Closing the System](#)" in "Troubleshooting Your System."
6. Reconnect the system to the electrical outlet, and turn on the system and attached peripherals.

Installing a Hard Drive

CAUTION: Only trained service technicians are authorized to remove the system cover and access any of the components inside the system. Before performing any procedure, see your *Product Information Guide* for complete information about safety precautions, working inside the computer and protecting against electrostatic discharge.

1. Turn off the system and attached peripherals, and disconnect the system from the electrical outlet.
2. Open the system. See "[Opening the System](#)" in "Troubleshooting Your System."
3. Unpack the hard drive, and prepare it for installation.
4. Check the documentation for the drive to verify that it is configured for your system.
5. Remove the plastic guide bracket from the drive bay by pressing the two tabs inward and lifting it out. See [Figure 6-2](#) or [Figure 6-3](#).
6. Snap the new drive into the guide bracket and insert the guide bracket assembly into the drive bay until it snaps into place. See [Figure 6-4](#).

Figure 6-4. Removing and Installing a Hard Drive in the Guide Bracket Assembly

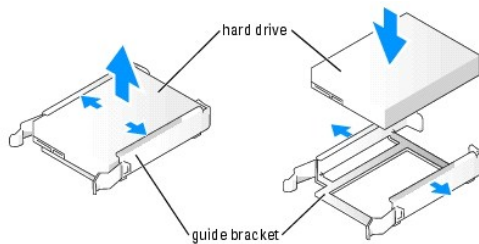

7. Connect the power cable to the drive. See [Figure 6-2](#) or [Figure 6-3](#).
8. Connect the interface cable to the drive:
 1. Connect SATA hard drives to the SATA0 (first drive) and SATA2 (second drive) connectors on the system board. See [Figure A-3](#) for the location of the drive interface connectors on the system board.
 1. Connect SCSI hard drives to the SCSI controller card at channel A. See the documentation for the controller card and "[Installing an Expansion](#)"

[Card](#) in "Installing System Options."

9. Close the system. See "[Closing the System](#)" in "Troubleshooting Your System."
10. Reconnect the system to the electrical outlet, and turn on the system and attached peripherals.
11. Enter the System Setup program and ensure that the drive's controller is enabled. See "Using the System Setup Program" in your *User's Guide*.
12. Partition and logically format your drive before proceeding to the next step.
See the documentation for your operating system for instructions.
13. Test the hard drive by running the system diagnostics. See "[Running the System Diagnostics](#)."
14. If the drive you just installed is the primary drive, install your operating system on the hard drive.

Installing a SCSI Controller Card

See "[Installing an Expansion Card](#)" in "Installing System Options" for instructions about installing the card and routing the cables. Also see [Figure 6-2](#) for additional cable routing details.

 **NOTE:** Most SCSI controller cards are capable of sending a drive activity indicator signal that powers a drive activity LED. This signal is sent via a cable from the controller card connected to the AUX_LED connector on the system board. See [Figure A-3](#) for connector locations.

Installing a Diskette Drive

The system supports an optional standard diskette drive.

Removing the Diskette Drive

 **CAUTION:** Only trained service technicians are authorized to remove the system cover and access any of the components inside the system. Before performing any procedure, see your *Product Information Guide* for complete information about safety precautions, working inside the computer and protecting against electrostatic discharge.

1. Turn off the system and attached peripherals, and disconnect the system from the electrical outlet.
2. Open the system. See "[Opening the System](#)" in "Troubleshooting Your System."
3. Remove the front drive bezel. See "[Removing and Replacing the Front Drive Bezel](#)" in "Troubleshooting Your System."
4. Disconnect the power and interface cables from the diskette drive. See [Figure 6-6](#).
5. Pull the drive bay sliding plate downward in the direction of the arrow on the plate. See [Figure 6-6](#).
6. Hold the sliding plate in position and slowly pull the drive out of the bay.
7. If the drive is being permanently removed, install a front drive panel insert. See "[Removing and Replacing the Front Drive Bezel Insert](#)" in "Troubleshooting Your System."
8. Replace the front drive bezel. See "[Removing and Replacing the Front Drive Bezel](#)" in "Troubleshooting Your System."
9. Close the system. See "[Closing the System](#)" in "Troubleshooting Your System."
10. Reconnect the system to the electrical outlet, and turn on the system and attached peripherals.

Installing a Diskette Drive

 **CAUTION:** Only trained service technicians are authorized to remove the system cover and access any of the components inside the system. Before performing any procedure, see your *Product Information Guide* for complete information about safety precautions, working inside the computer and protecting against electrostatic discharge.

1. Turn off the system and attached peripherals, and disconnect the system from the electrical outlet.

2. Open the system. See "[Opening the System](#)" in "Troubleshooting Your System."
3. Unpack the replacement diskette drive, and prepare it for installation.
4. Check the documentation for the drive to verify that it is configured for your system.
5. Attach the four shoulder screws to the drive as shown in [Figure 6-5](#).

NOTE: Spare shoulder screws are attached to the inside of the front drive bezel.

6. Remove the front drive bezel. See "[Removing and Replacing the Front Drive Bezel](#)" in "Troubleshooting Your System."

Figure 6-5. Installing Diskette Drive Shoulder Screws

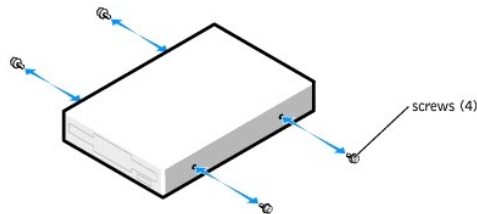

7. Remove the front drive panel insert. See "[Removing and Replacing the Front Drive Bezel Insert](#)" in "Troubleshooting Your System."
8. Verify that the drive-stop tab is in the proper position. It should be in its lowermost position so that the diskette icon on the drive cage is visible. See [Figure 6-6](#).

NOTE: Inserting a diskette drive into the drive bay with the drive-stop tab in the improper position will cause the drive to be positioned too deep in the bay.

9. From the front of the chassis, slide the drive into the drive bay until the shoulder screws snap securely into the sliding plate.
10. Connect the power cable to the drive. See [Figure 6-6](#).

Figure 6-6. Removing or Installing an Optional Diskette Drive

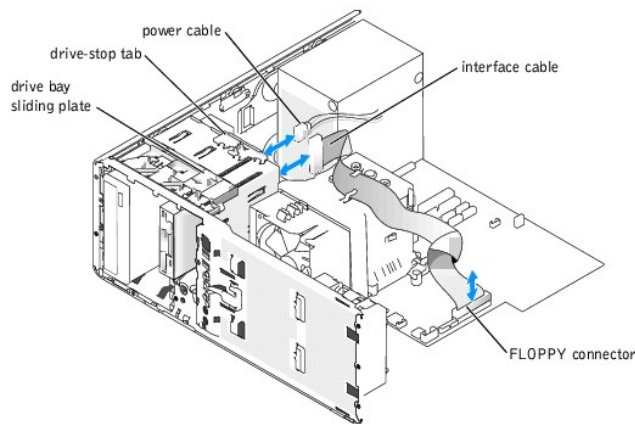

11. Connect the interface cable from the drive to the FLOPPY connector on the system board. See [Figure 6-6](#) and [Figure A-3](#).
12. Close the system. See "[Closing the System](#)" in "Troubleshooting Your System."
13. Replace the front drive bezel. See "[Removing and Replacing the Front Drive Bezel](#)" in "Troubleshooting Your System."
14. Reconnect the system to the electrical outlet, and turn on the system and attached peripherals.
15. Enter the System Setup program and ensure that the drive's controller is enabled. See "Using the System Setup Program" in your *User's Guide*.

16. Test the drive by running the system diagnostics. See "[Running the System Diagnostics](#)."

Installing 5.25-Inch Optical and Tape Drives

You can install an additional 5.25-inch drive of your choice in the second 5.25-inch drive bay. See [Figure 6-1](#). If you are installing a tape backup unit (TBU), it must be installed in the second bay.

Installing a 5.25-Inch Drive

CAUTION: Only trained service technicians are authorized to remove the system cover and access any of the components inside the system. Before performing any procedure, see your *Product Information Guide* for complete information about safety precautions, working inside the computer and protecting against electrostatic discharge.

1. Unpack the drive and prepare the drive for installation.

For instructions, see the documentation that accompanied the drive. Also, see "[SCSI Installation Guidelines](#)" for information on configuring the drive.

2. Attach the three shoulder screws to the drive. See [Figure 6-7](#).

NOTE: Spare shoulder screws are attached to the inside of the front drive bezel.

Figure 6-7. Installing 5.25-Inch Drive Shoulder Screws

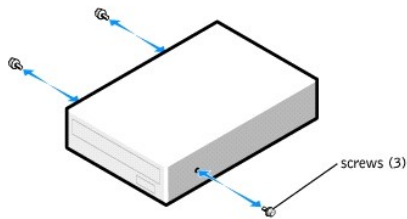

3. Turn off the system, including any attached peripherals, and disconnect the system from the electrical outlet.
4. Open the system. See "[Opening the System](#)" in "Troubleshooting Your System."
5. Remove the front drive bezel. See "[Removing and Replacing the Front Drive Bezel](#)" in "Troubleshooting Your System."
6. If necessary, remove the front-panel insert for the empty drive bay. See "[Removing and Replacing the Front Drive Bezel Insert](#)."
7. From the front of the chassis, slide the drive into the drive bay until the shoulder screws snap securely into the sliding plate.
8. Connect the power cable to the drive. See [Figure 6-8](#).

Figure 6-8. Installing a 5.25-Inch Drive

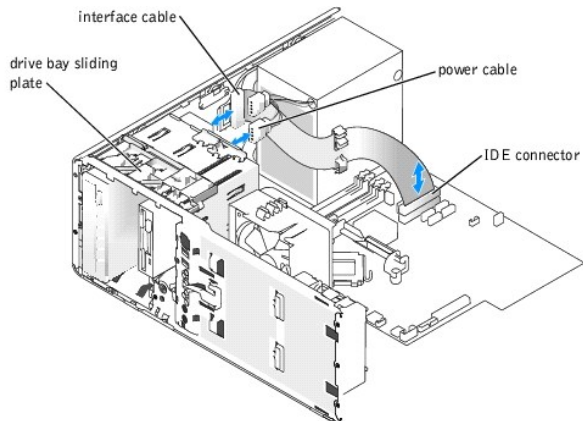

9. Connect the interface cable from the drive to the IDE connector on the system board to the drive. See [Figure 6-8](#) and [Figure A-3](#).
 10. Close the system. See "[Closing the System](#)" in "Troubleshooting Your System."
 11. Replace the front drive bezel. See "[Removing and Replacing the Front Drive Bezel](#)" in "Troubleshooting Your System."
 12. Reconnect the system to the electrical outlet, and turn on the system and attached peripherals.
 13. Enter the System Setup program and ensure that the drive's IDE controller is enabled. See "Using the System Setup Program" in your *User's Guide*.
 14. Test the drive by running the system diagnostics. See "[Running the System Diagnostics](#)."
-

[Back to Contents Page](#)

Service Only Parts Replacement Procedures

Dell™ PowerEdge™ SC430 Systems Installation and Troubleshooting Guide

- [Before You Begin](#)
 - [Recommended Tools](#)
 - [Removing and Replacing the Bezel](#)
 - [I/O Panel](#)
 - [Chassis Intrusion Switch](#)
 - [System Board](#)
-

Before You Begin

 **CAUTION:** Only trained service technicians are authorized to remove the system cover and access any of the components inside the system. Before performing any procedure, see your *Product Information Guide* for complete information about safety precautions, working inside the computer and protecting against electrostatic discharge.

Recommended Tools

You may need the following items to perform the procedures in this section:

- 1 #2 Phillips screwdriver
 - 1 Wrist grounding strap
-

Removing and Replacing the Bezel

Removing the Bezel

 **CAUTION:** Only trained service technicians are authorized to remove the system cover and access any of the components inside the system. Before performing any procedure, see your *Product Information Guide* for complete information about safety precautions, working inside the computer and protecting against electrostatic discharge.

1. Turn off the system and attached peripherals, and disconnect the system from the electrical outlet.
2. Open the system. See "[Opening the System](#)" in "Troubleshooting Your System."
3. Remove the processor heat sink and shroud assembly. See "[Removing the Processor](#)" in "[Installing System Options](#)."
4. Remove the large processor cooling fan. See "[Replacing the Cooling Fans](#)" in "Installing System Options."
5. Remove the I/O panel as explained in [step 6](#) through [step 8](#) in "[Removing the I/O Panel](#)."
6. Remove the three bezel release screws. See [Figure 7-1](#).
7. Slide the bezel toward the top of the system chassis, then lift outward.

Figure 7-1. Removing the Bezel

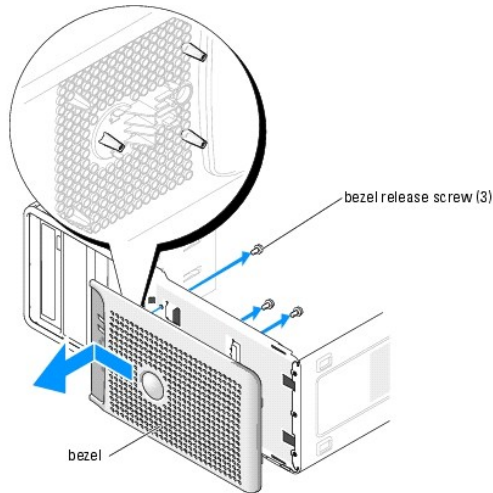

Replacing the Bezel

1. Align the bezel with the chassis frame and slide it down into position.
2. Attach the three bezel release screws to secure the bezel to the system chassis. See [Figure 7-1](#).
3. Reinstall the I/O panel as explained in [step 6](#) through [step 8](#) in "[Replacing the I/O Panel](#)."
4. Reinstall the processor cooling fan. See "[Replacing the Cooling Fans](#)" in "Installing System Options."
5. Reinstall the processor heat sink and shroud assembly. See "[Replacing the Processor](#)" in "Installing System Options."
6. Close the system. See "[Closing the System](#)" in "Troubleshooting Your System."
7. Reconnect the system to the electrical outlet, and turn on the system.

I/O Panel

⚠ CAUTION: Only trained service technicians are authorized to remove the system cover and access any of the components inside the system. Before performing any procedure, see your *Product Information Guide* for complete information about safety precautions, working inside the computer and protecting against electrostatic discharge.

Removing the I/O Panel

1. Turn off the system and attached peripherals, and disconnect the system from the electrical outlet.
2. Remove the system cover. See "[Opening the System](#)" in "Troubleshooting Your System."
3. Remove the heat sink and shroud assembly. See "[Removing the Processor](#)" in "Installing System Options."
4. Remove the large processor cooling fan. See "[Replacing the Cooling Fans](#)" in "Installing System Options."
5. Remove the front bezel. See "[Removing and Replacing the Bezel](#)."
6. Disconnect the I/O panel ribbon cable from the I/O panel connector by pulling the yellow cable loop.
7. Remove the mounting screw holding the I/O panel bracket assembly to the front chassis. See [Figure 7-2](#).
8. Lift the I/O panel out of the system. See [Figure 7-2](#).

Figure 7-2. I/O-Panel Components

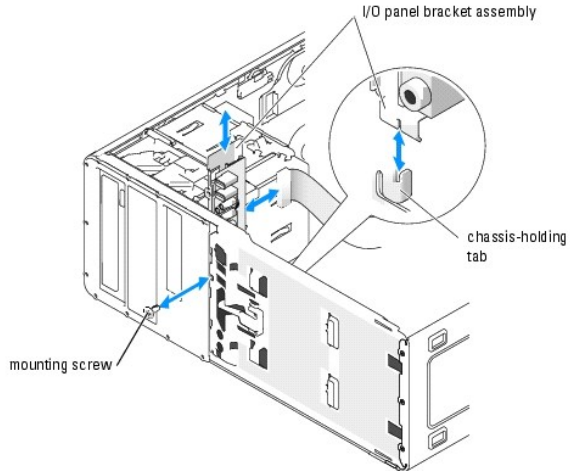

Replacing the I/O Panel

CAUTION: Only trained service technicians are authorized to remove the system cover and access any of the components inside the system. Before performing any procedure, see your *Product Information Guide* for complete information about safety precautions, working inside the computer and protecting against electrostatic discharge.

1. If system is powered on, turn off the system and attached peripherals, and disconnect the system from the electrical outlet.
2. Remove the system cover. See "[Opening the System](#)" in "Troubleshooting Your System."
3. Remove the heat sink and shroud assembly. See "[Removing the Processor](#)" in "Installing System Options."
4. Remove the large processor cooling fan. See "[Replacing the Cooling Fans](#)" in "[Installing System Options](#)."
5. Remove the front bezel. See "[Removing and Replacing the Bezel](#)."
6. Fit the I/O panel bracket assembly into the holding tab on the front of the chassis. See [Figure 7-2](#).
7. Secure the I/O panel bracket assembly by installing the mounting screw. See [Figure 7-2](#).
8. Connect the I/O panel ribbon cable to the new I/O panel connector.
9. Reinstall the large processor cooling fan. See "[Replacing the Cooling Fans](#)" in "Installing System Options."
10. Reinstall the processor heat sink and shroud assembly. See "[Replacing the Processor](#)" in "[Installing System Options](#)."

NOTE: To prevent damaging the processor, clean the heat sink to remove any thermal grease and then apply fresh thermal grease to the processor before installing the heat sink.

11. Close the system. See "[Closing the System](#)" in "Troubleshooting Your System."
12. Reconnect the system to the electrical outlet, and turn on the system.

Chassis Intrusion Switch

Removing the Chassis Intrusion Switch

CAUTION: Only trained service technicians are authorized to remove the system cover and access any of the components inside the system. Before performing any procedure, see your *Product Information Guide* for complete information about safety precautions, working inside the computer and protecting against electrostatic discharge.

1. Turn off the system and attached peripherals, and disconnect the system from the electrical outlet.
2. Open the system. See "[Opening the System](#)" in "Troubleshooting Your System."
3. Disconnect the chassis intrusion switch cable from the INTRUDER connector on the system board. See [Figure 7-3](#).
4. Slide the chassis intrusion switch out of the securing bracket notch. See [Figure 7-3](#).

Figure 7-3. Removing and Installing the Chassis Intrusion Switch

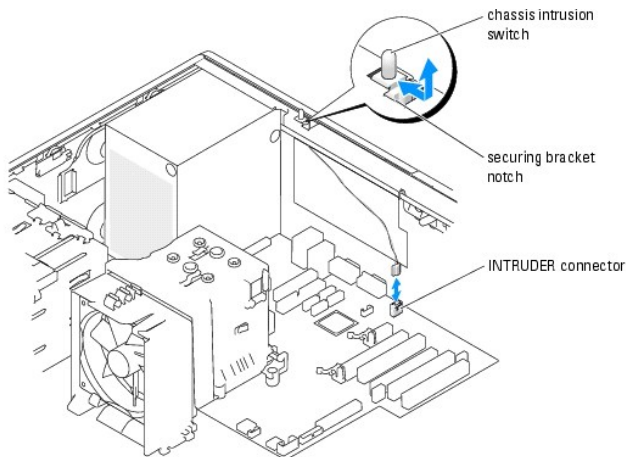

5. Remove the switch and its attached cable from the system.

Installing the Chassis Intrusion Switch

1. Align the chassis intrusion switch with the securing bracket notch. See [Figure 7-3](#).
2. Slide the switch into the securing bracket notch.
3. Connect the switch cable to the INTRUDER connector on the system board.
4. Close the system. See "[Closing the System](#)" in "Troubleshooting Your System."
5. Reconnect the system to the electrical outlet, and turn on the system.

System Board

⚠ CAUTION: Only trained service technicians are authorized to remove the system cover and access any of the components inside the system. Before performing any procedure, see your *Product Information Guide* for complete information about safety precautions, working inside the computer and protecting against electrostatic discharge.

⚠ CAUTION: The heat sink can get hot during operation. To avoid burns, ensure that the system has sufficient time to cool before removing the system board.

The system board and system board tray are removed and replaced as a single assembly.

Removing the System Board

1. Turn off the system and attached peripherals, and disconnect the system from the electrical outlet.
2. Open the system. See "[Opening the System](#)" in "Troubleshooting Your System."
3. Disconnect the following cables from the system board. See [Figure A-3](#).
 - 1 Two power-supply cables from the POWER P1 and POWER P2 connectors

- 1 If applicable, diskette data cable from the FLOPPY connector
 - 1 I/O panel cable from the FRONT PANEL connector
 - 1 5.25-inch device data cable from the IDE connector
 - 1 Processor cooling fan cable from the FAN_CPU connector
 - 1 Card cage cooling fan cable from the CARD CAGE COOLING FAN connector
 - 1 If applicable, SATA hard-drive data cable(s) from the SATA connector(s)
4. Remove all expansion cards and any attached cables. See "[Removing an Expansion Card](#)" in "Installing System Options."
 5. Remove all memory modules. See "[Removing a Memory Module](#)" in "[Installing System Options](#)."

 **NOTE:** Record the memory-module socket locations to ensure proper reinstallation of the memory modules.

 **CAUTION:** The processor and heat sink can become extremely hot. Allow sufficient time for the processor and heat sink to cool before handling.

 **NOTICE:** To prevent damaging the processor, do not pry the heat sink off of the processor.

6. Remove the processor. See "[Removing the Processor](#)" in "Installing System Options."
7. Using a #2 Phillips screwdriver, remove the eight system board mounting screws that secure the system board to the chassis. See [Figure 7-4](#).
8. Using a #2 Phillips screwdriver, remove the two processor heat sink pivot mount screws and remove the pivot mount from the system board. See [Figure 7-4](#).

Figure 7-4. System Board Mounting Points

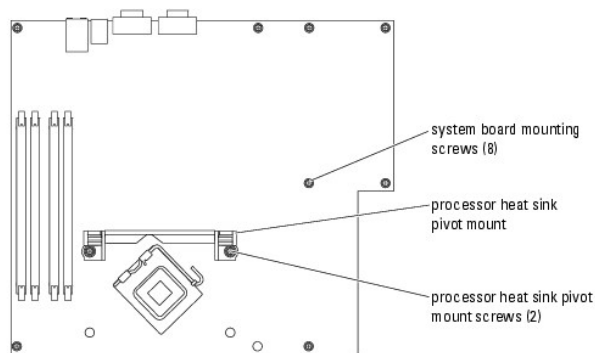

9. Carefully route any loose cables away from the edges of the system board.
10. Gently slide the system board toward the front of the system, then lift the system board up and out of the chassis.
11. Place the system board tray on a flat, nonconductive surface.

Installing the System Board

1. Lower the system board into the chassis, aligning the I/O ports on the system board with the I/O connector openings on the back panel of the chassis.
 2. Using a #2 Phillips screwdriver, install the eight screws on the system board that secure it to the chassis. See [Figure 7-4](#).
 3. Using a #2 Phillips screwdriver, attach the processor heat sink pivot mount to the system board.
-  **NOTICE:** To prevent damaging the processor, clean the heat sink to remove any thermal grease and then apply fresh thermal grease to the processor before installing the heat sink.
4. Install the processor. See "[Replacing the Processor](#)" in "Installing System Options."
 5. Install the memory modules in the same sockets from which they were removed. See "[Installing a Memory Module](#)" in "Installing System Options."
 6. Install the expansion cards and connect any cables. See "[Installing an Expansion Card](#)" in "Installing System Options."

7. Connect the following cables that you removed in "[Removing the System Board](#)." See [Figure A-3](#).
 - 1 Two power-supply cables to the POWER P1 and POWER P2 connectors
 - 1 If applicable, diskette data cable to the FLOPPY connector
 - 1 I/O panel cable to the FRONT PANEL connector
 - 1 5.25-inch device data cable to the IDE connector
 - 1 Processor cooling fan cable to the FAN_CPU connector
 - 1 Card cage cooling fan cable to the CARD CAGE COOLING FAN connector
 - 1 If applicable, SATA hard-drive data cable(s) to the SATA connector(s)
 8. Close the system. See "[Closing the System](#)" in "[Troubleshooting Your System](#)."
 9. Reconnect the system to the electrical outlet, and turn on the system.
-

[Back to Contents Page](#)

[Back to Contents Page](#)

Getting Help

Dell™ PowerEdge™ SC430 Systems Installation and Troubleshooting Guide

- [Technical Assistance](#)
 - [Dell Enterprise Training and Certification](#)
 - [Problems With Your Order](#)
 - [Product Information](#)
 - [Returning Items for Warranty Repair or Credit](#)
 - [Before You Call](#)
 - [Contacting Dell](#)
-

Technical Assistance

If you need assistance with a technical problem, perform the following steps:

1. Complete the procedures in "[Troubleshooting Your System](#)."
2. Run the system diagnostics and record any information provided.
3. Make a copy of the [Diagnostics Checklist](#), and fill it out.
4. Use Dell's extensive suite of online services available at Dell Support at support.dell.com for help with installation and troubleshooting procedures.

For more information, see "[Online Services](#)."

5. If the preceding steps have not resolved the problem, call Dell for technical assistance.

NOTE: Call technical support from a phone near or at the system so that technical support can assist you with any necessary procedures.

NOTE: Dell's Express Service Code system may not be available in all countries.

When prompted by Dell's automated telephone system, enter your Express Service Code to route the call directly to the proper support personnel. If you do not have an Express Service Code, open the **Dell Accessories** folder, double-click the **Express Service Code** icon, and follow the directions.

For instructions on using the technical support service, see "[Technical Support Service](#)" and "[Before You Call](#)."

NOTE: Some of the following services are not always available in all locations outside the continental U.S. Call your local Dell representative for information on availability.

Online Services

You can access Dell Support at support.dell.com. Select your region on the **WELCOME TO DELL SUPPORT** page, and fill in the requested details to access help tools and information.

You can contact Dell electronically using the following addresses:

- 1 World Wide Web

www.dell.com/

www.dell.com/ap/ (Asian/Pacific countries only)

www.dell.com/jp (Japan only)

www.euro.dell.com (Europe only)

www.dell.com/la (Latin American countries)

www.dell.ca (Canada only)

- 1 Anonymous file transfer protocol (FTP)

[ftp.dell.com/](ftp://ftp.dell.com/)

Log in as user:anonymous, and use your e-mail address as your password.

- 1 Electronic Support Service

support@us.dell.com

apsupport@dell.com (Asian/Pacific countries only)

support.jp.dell.com (Japan only)

support.euro.dell.com (Europe only)

1 Electronic Quote Service

sales@dell.com

apmarketing@dell.com (Asian/Pacific countries only)

sales_canada@dell.com (Canada only)

1 Electronic Information Service

info@dell.com

AutoTech Service

Dell's automated technical support service—AutoTech—provides recorded answers to the questions most frequently asked by Dell customers about their portable and desktop computer systems.

When you call AutoTech, use your touch-tone telephone to select the subjects that correspond to your questions.

The AutoTech service is available 24 hours a day, 7 days a week. You can also access this service through the technical support service. See the contact information for your region.

Automated Order-Status Service

To check on the status of any Dell™ products that you have ordered, you can go to **support.dell.com**, or you can call the automated order-status service. A recording prompts you for the information needed to locate and report on your order. See the contact information for your region.

Technical Support Service

Dell's technical support service is available 24 hours a day, 7 days a week, to answer your questions about Dell hardware. Our technical support staff use computer-based diagnostics to provide fast, accurate answers.

To contact Dell's technical support service, see "[Before You Call](#)" and then see the contact information for your region.

Dell Enterprise Training and Certification

Dell Enterprise Training and Certification is available; see www.dell.com/training for more information. This service may not be offered in all locations.

Problems With Your Order

If you have a problem with your order, such as missing parts, wrong parts, or incorrect billing, contact Dell for customer assistance. Have your invoice or packing slip available when you call. See the contact information for your region.

Product Information

If you need information about additional products available from Dell, or if you would like to place an order, visit the Dell website at www.dell.com. For the telephone number to call to speak to a sales specialist, see the contact information for your region.

Returning Items for Warranty Repair or Credit

Prepare all items being returned, whether for repair or credit, as follows:

1. Call Dell to obtain a Return Material Authorization Number, and write it clearly and prominently on the outside of the box.

For the telephone number to call, see the contact information for your region.

2. Include a copy of the invoice and a letter describing the reason for the return.

3. Include a copy of any diagnostic information (including the Diagnostics Checklist) indicating the tests you have run and any error messages reported by

the system diagnostics.

4. Include any accessories that belong with the item(s) being returned (such as power cables, media such as CDs and diskettes, and guides) if the return is for credit.
5. Pack the equipment to be returned in the original (or equivalent) packing materials.

You are responsible for paying shipping expenses. You are also responsible for insuring any product returned, and you assume the risk of loss during shipment to Dell. Collect-on-delivery (C.O.D.) packages are not accepted.

Returns that are missing any of the preceding requirements will be refused at our receiving dock and returned to you.

Before You Call

NOTE: Have your Express Service Code ready when you call. The code helps Dell's automated-support telephone system direct your call more efficiently.

Remember to fill out the [Diagnostics Checklist](#). If possible, turn on your system before you call Dell for technical assistance and call from a telephone at or near the computer. You may be asked to type some commands at the keyboard, relay detailed information during operations, or try other troubleshooting steps possible only at the computer system itself. Ensure that the system documentation is available.

 **CAUTION:** Before servicing any components inside your computer, see your *Product Information Guide* for important safety information.

Diagnostics Checklist
Name:
Date:
Address:
Phone number:
Service Tag (bar code on the back of the computer):
Express Service Code:
Return Material Authorization Number (if provided by Dell support technician):
Operating system and version:
Peripherals:
Expansion cards:
Are you connected to a network? Yes No
Network, version, and network card:
Programs and versions:
See your operating system documentation to determine the contents of the system's start-up files. If possible, print each file. Otherwise, record the contents of each file before calling Dell.
Error message, beep code, or diagnostic code:
Description of problem and troubleshooting procedures you performed:

Contacting Dell

To contact Dell electronically, you can access the following websites:

- 1 www.dell.com
- 1 support.dell.com (technical support)
- 1 premiersupport.dell.com (technical support for educational, government, healthcare, and medium/large business customers, including Premier, Platinum, and Gold customers)

For specific web addresses for your country, find the appropriate country section in the table below.

 **NOTE:** Toll-free numbers are for use within the country for which they are listed.

NOTE: In certain countries, technical support specific to Dell Inspiron™ XPS computers is available at a separate telephone number listed for participating countries. If you do not see a telephone number listed that is specific for Inspiron XPS computers, you may contact Dell through the technical support number listed and your call will be routed appropriately.

When you need to contact Dell, use the electronic addresses, telephone numbers, and codes provided in the following table. If you need assistance in

determining which codes to use, contact a local or an international operator.

Country (City) International Access Code Country Code City Code	Department Name or Service Area, Website and E-Mail Address	Area Codes, Local Numbers, and Toll-Free Numbers
Anguilla	General Support	toll-free: 800-335-0031
Antigua and Barbuda	General Support	1-800-805-5924
Argentina (Buenos Aires) International Access Code: 00 Country Code: 54 City Code: 11	Website: www.dell.com.ar	
	E-mail: us_latin_services@dell.com	
	E-mail for desktop and portable computers: la_techsupport@dell.com	
	E-mail for servers and EMC® storage products: la_enterprise@dell.com	
	Customer Care	toll-free: 0-800-444-0730
	Tech Support	toll-free: 0-800-444-0733
	Tech Support Services	toll-free: 0-800-444-0724
Sales	0-810-444-3355	
Aruba	General Support	toll-free: 800-1578
Australia (Sydney) International Access Code: 0011 Country Code: 61 City Code: 2	E-mail (Australia): au_tech_support@dell.com	
	E-mail (New Zealand): nz_tech_support@dell.com	
	Home and Small Business	1-300-655-533
	Government and Business	toll-free: 1-800-633-559
	Preferred Accounts Division (PAD)	toll-free: 1-800-060-889
	Customer Care	toll-free: 1-800-819-339
	Technical Support (portables and desktops)	toll-free: 1-300-655-533
	Technical Support (servers and workstations)	toll-free: 1-800-733-314
	Corporate Sales	toll-free: 1-800-808-385
	Transaction Sales	toll-free: 1-800-808-312
Fax	toll-free: 1-800-818-341	
Austria (Vienna) International Access Code: 900 Country Code: 43 City Code: 1	Website: support.euro.dell.com	
	E-mail: tech_support_central_europe@dell.com	
	Home/Small Business Sales	0820 240 530 00
	Home/Small Business Fax	0820 240 530 49
	Home/Small Business Customer Care	0820 240 530 14
	Preferred Accounts/Corporate Customer Care	0820 240 530 16
	Home/Small Business Technical Support	0820 240 530 14
	Preferred Accounts/Corporate Technical Support	0660 8779
	Switchboard	0820 240 530 00
Bahamas	General Support	toll-free: 1-866-278-6818
Barbados	General Support	1-800-534-3066
Belgium (Brussels) International Access Code: 00 Country Code: 32 City Code: 2	Website: support.euro.dell.com	
	E-mail for French-speaking Customers: support.euro.dell.com/be/fr/emaildell/	
	Technical Support for Inspiron XPS computers only	02 481 92 96
	Technical Support for all other Dell computers	02 481 92 88
	Technical Support Fax	02 481 92 95
	Customer Care	02 713 15 .65
	Corporate Sales	02 481 91 00
	Fax	02 481 92 99
Switchboard	02 481 91 00	
Bermuda	General Support	1-800-342-0671
Bolivia	General Support	toll-free: 800-10-0238
Brazil International Access Code: 00 Country Code: 55 City Code: 51	Website: www.dell.com/br	
	Customer Support, Technical Support	0800 90 3355
	Technical Support Fax	51 481 5470
	Customer Care Fax	51 481 5480
	Sales	0800 90 3390
British Virgin Islands	General Support	toll-free: 1-866-278-6820
Brunei	Customer Technical Support (Penang, Malaysia)	604 633 4966

Country Code: 673	Customer Service (Penang, Malaysia)	604 633 4949
	Transaction Sales (Penang, Malaysia)	604 633 4955
Canada (North York, Ontario) International Access Code: 011	Online Order Status: www.dell.ca/ostatus	
	AutoTech (automated technical support)	toll-free: 1-800-247-9362
	Customer Care (Home Sales/Small Business)	toll-free: 1-800-847-4096
	Customer Care (med./large business, government)	toll-free: 1-800-326-9463
	Technical Support (Home Sales/Small Business)	toll-free: 1-800-847-4096
	Technical Support (med./large bus., government)	toll-free: 1-800-387-5757
	Technical Support (printers, projectors, televisions, handhelds, digital jukebox, and wireless)	1-877-335-5767
	Sales (Home Sales/Small Business)	toll-free: 1-800-387-5752
	Sales (med./large bus., government)	toll-free: 1-800-387-5755
	Spare Parts Sales & Extended Service Sales	1 866 440 3355
Cayman Islands	General Support	1-800-805-7541
Chile (Santiago) Country Code: 56 City Code: 2	Sales, Customer Support, and Technical Support	toll-free: 1230-020-4823
China (Xiamen) Country Code: 86 City Code: 592	Technical Support website: support.dell.com.cn	
	Technical Support E-mail: cn_support@dell.com	
	Customer Care E-mail: customer_cn@dell.com	
	Technical Support Fax	592 818 1350
	Technical Support (Dell™ Dimension™ and Inspiron)	toll-free: 800 858 2969
	Technical Support (OptiPlex™, Latitude™, and Dell Precision™)	toll-free: 800 858 0950
	Technical Support (servers and storage)	toll-free: 800 858 0960
	Technical Support (projectors, PDAs, switches, routers, and so on)	toll-free: 800 858 2920
	Technical Support (printers)	toll-free: 800 858 2311
	Customer Care	toll-free: 800 858 2060
	Customer Care Fax	592 818 1308
	Home and Small Business	toll-free: 800 858 2222
	Preferred Accounts Division	toll-free: 800 858 2557
	Large Corporate Accounts GCP	toll-free: 800 858 2055
	Large Corporate Accounts Key Accounts	toll-free: 800 858 2628
	Large Corporate Accounts North	toll-free: 800 858 2999
	Large Corporate Accounts North Government and Education	toll-free: 800 858 2955
	Large Corporate Accounts East	toll-free: 800 858 2020
	Large Corporate Accounts East Government and Education	toll-free: 800 858 2669
Large Corporate Accounts Queue Team	toll-free: 800 858 2572	
Large Corporate Accounts South	toll-free: 800 858 2355	
Large Corporate Accounts West	toll-free: 800 858 2811	
Large Corporate Accounts Spare Parts	toll-free: 800 858 2621	
Colombia	General Support	980-9-15-3978
Costa Rica	General Support	0800-012-0435
Czech Republic (Prague) International Access Code: 00 Country Code: 420	Website: support.euro.dell.com	
	E-mail: czech_dell@dell.com	
	Technical Support	22537 2727
	Customer Care	22537 2707
	Fax	22537 2714
	Tech Fax	22537 2728
Switchboard	22537 2711	
Denmark (Copenhagen) International Access Code: 00 Country Code: 45	Website: support.euro.dell.com	
	E-mail: support.euro.dell.com/dk/da/emaildell/	
	Technical Support for Inspiron XPS computers only	7010 0074
	Technical Support for all other Dell computers	7023 0182
	Customer Care (Relational)	7023 0184
	Home/Small Business Customer Care	3287 5505
Switchboard (Relational)	3287 1200	
Switchboard Fax (Relational)	3287 1201	

	Switchboard (Home/Small Business)	3287 5000
	Switchboard Fax (Home/Small Business)	3287 5001
Dominica	General Support	toll-free: 1-866-278-6821
Dominican Republic	General Support	1-800-148-0530
Ecuador	General Support	toll-free: 999-119
El Salvador	General Support	01-899-753-0777
Finland (Helsinki) International Access Code: 990 Country Code: 358 City Code: 9	Website: support.euro.dell.com	
	E-mail: support.euro.dell.com/fi/fi/emaildell/	
	Technical Support	09 253 313 60
	Customer Care	09 253 313 38
	Fax	09 253 313 99
	Switchboard	09 253 313 00
France (Paris) (Montpellier) International Access Code: 00 Country Code: 33 City Codes: (1) (4)	Website: support.euro.dell.com	
	E-mail: support.euro.dell.com/fr/fr/emaildell/	
	Home and Small Business	
	Technical Support for Inspiron XPS computers only	0825 387 129
	Technical Support for all other Dell computers	0825 387 270
	Customer Care	0825 823 833
	Switchboard	0825 004 700
	Switchboard (calls from outside of France)	04 99 75 40 00
	Sales	0825 004 700
	Fax	0825 004 701
	Fax (calls from outside of France)	04 99 75 40 01
	Corporate	
	Technical Support	0825 004 719
	Customer Care	0825 338 339
	Switchboard	01 55 94 71 00
Sales	01 55 94 71 00	
Fax	01 55 94 71 01	
Germany (Langen) International Access Code: 00 Country Code: 49 City Code: 6103	Website: support.euro.dell.com	
	E-mail: tech_support_central_europe@dell.com	
	Technical Support for Inspiron XPS computers only	06103 766-7222
	Technical Support for all other Dell computers	06103 766-7200
	Home/Small Business Customer Care	0180-5-224400
	Global Segment Customer Care	06103 766-9570
	Preferred Accounts Customer Care	06103 766-9420
	Large Accounts Customer Care	06103 766-9560
	Public Accounts Customer Care	06103 766-9555
Switchboard	06103 766-7000	
Greece International Access Code: 00 Country Code: 30	Website: support.euro.dell.com	
	E-mail: support.euro.dell.com/gr/en/emaildell/	
	Technical Support	00800-44 14 95 18
	Gold Service Technical Support	00800-44 14 00 83
	Switchboard	2108129810
	Gold Service Switchboard	2108129811
	Sales	2108129800
Fax	2108129812	
Grenada	General Support	toll-free: 1-866-540-3355
Guatemala	General Support	1-800-999-0136
Guyana	General Support	toll-free: 1-877-270-4609
Hong Kong International Access Code: 001 Country Code: 852	Website: support.ap.dell.com	
	Technical Support E-mail: apsupport@dell.com	
	Technical Support (Dimension and Inspiron)	2969 3188
	Technical Support (OptiPlex, Latitude, and Dell Precision)	2969 3191
	Technical Support (PowerApp™, PowerEdge™, PowerConnect™, and PowerVault™)	2969 3196
	Customer Care	3416 0910
	Large Corporate Accounts	3416 0907
Global Customer Programs	3416 0908	

	Medium Business Division	3416 0912
	Home and Small Business Division	2969 3105
India	Technical Support	1600 33 8045
	Sales (Large Corporate Accounts)	1600 33 8044
	Sales (Home and Small Business)	1600 33 8046
Ireland (Cherrywood) International Access Code: 16 Country Code: 353 City Code: 1	Website: support.euro.dell.com	
	E-mail: dell_direct_support@dell.com	
	Technical Support for Inspiron XPS computers only	1850 200 722
	Technical Support for all other Dell computers	1850 543 543
	U.K. Technical Support (dial within U.K. only)	0870 908 0800
	Home User Customer Care	01 204 4014
	Small Business Customer Care	01 204 4014
	U.K. Customer Care (dial within U.K. only)	0870 906 0010
	Corporate Customer Care	1850 200 982
	Corporate Customer Care (dial within U.K. only)	0870 907 4499
	Ireland Sales	01 204 4444
	U.K. Sales (dial within U.K. only)	0870 907 4000
	Fax/Sales Fax	01 204 0103
	Switchboard	01 204 4444
Italy (Milan) International Access Code: 00 Country Code: 39 City Code: 02	Website: support.euro.dell.com	
	E-mail: support.euro.dell.com/it/it/emaildell/	
	Home and Small Business	
	Technical Support	02 577 826 90
	Customer Care	02 696 821 14
	Fax	02 696 821 13
	Switchboard	02 696 821 12
	Corporate	
	Technical Support	02 577 826 90
	Customer Care	02 577 825 55
	Fax	02 575 035 30
	Switchboard	02 577 821
Jamaica	General Support (dial from within Jamaica only)	1-800-682-3639
Japan (Kawasaki) International Access Code: 001 Country Code: 81 City Code: 44	Website: support.jp.dell.com	
	Technical Support (servers)	toll-free: 0120-198-498
	Technical Support outside of Japan (servers)	81-44-556-4162
	Technical Support (Dimension and Inspiron)	toll-free: 0120-198-226
	Technical Support outside of Japan (Dimension and Inspiron)	81-44-520-1435
	Technical Support (Dell Precision, OptiPlex, and Latitude)	toll-free: 0120-198-433
	Technical Support outside of Japan (Dell Precision, OptiPlex, and Latitude)	81-44-556-3894
	Technical Support (PDAs, projectors, printers, routers)	toll-free: 0120-981-690
	Technical Support outside of Japan (PDAs, projectors, printers, routers)	81-44-556-3468
	Faxbox Service	044-556-3490
	24-Hour Automated Order Service	044-556-3801
	Customer Care	044-556-4240
	Business Sales Division (up to 400 employees)	044-556-1465
	Preferred Accounts Division Sales (over 400 employees)	044-556-3433
	Large Corporate Accounts Sales (over 3500 employees)	044-556-3430
	Public Sales (government agencies, educational institutions, and medical institutions)	044-556-1469
	Global Segment Japan	044-556-3469
	Individual User	044-556-1760
	Switchboard	044-556-4300
Korea (Seoul) International Access Code: 001 Country Code: 82 City Code: 2	Technical Support	toll-free: 080-200-3800
	Sales	toll-free: 080-200-3600
	Customer Service (Penang, Malaysia)	604 633 4949
	Fax	2194-6202
	Switchboard	2194-6000
	Technical Support (Electronics and Accessories)	toll-free: 080-200-3801
	Customer Technical Support (Austin, Texas, U.S.A.)	512 728-4093

Latin America	Customer Service (Austin, Texas, U.S.A.)	512 728-3619
	Fax (Technical Support and Customer Service) (Austin, Texas, U.S.A.)	512 728-3883
	Sales (Austin, Texas, U.S.A.)	512 728-4397
	SalesFax (Austin, Texas, U.S.A.)	512 728-4600 or 512 728-3772
Luxembourg International Access Code: 00 Country Code: 352	Website: support.euro.dell.com	
	E-mail: tech_be@dell.com	
	Technical Support (Brussels, Belgium)	3420808075
	Home/Small Business Sales (Brussels, Belgium)	toll-free: 080016884
	Corporate Sales (Brussels, Belgium)	02 481 91 00
	Customer Care (Brussels, Belgium)	02 481 91 19
	Fax (Brussels, Belgium)	02 481 92 99
Macao Country Code: 853	Switchboard (Brussels, Belgium)	02 481 91 00
	Technical Support	toll-free: 0800 105
	Customer Service (Xiamen, China)	34 160 910
Malaysia (Penang) International Access Code: 00 Country Code: 60 City Code: 4	Transaction Sales (Xiamen, China)	29 693 115
	Website: support.ap.dell.com	
	Technical Support (Dell Precision, OptiPlex, and Latitude)	toll-free: 1 800 88 0193
	Technical Support (Dimension, Inspiron, and Electronics and Accessories)	toll-free: 1 800 88 1306
	Technical Support (PowerApp, PowerEdge, PowerConnect, and PowerVault)	toll-free: 1800 88 1386
	Customer Service (Penang, Malaysia)	04 633 4949
Mexico International Access Code: 00 Country Code: 52	Transaction Sales	toll-free: 1 800 888 202
	Corporate Sales	toll-free: 1 800 888 213
	Customer Technical Support	001-877-384-8979 or 001-877-269-3383
	Sales	50-81-8800 or 01-800-888-3355
	Customer Service	001-877-384-8979 or 001-877-269-3383
Montserrat	Main	50-81-8800 or 01-800-888-3355
	General Support	toll-free: 1-866-278-6822
Netherlands Antilles	General Support	001-800-882-1519
Netherlands (Amsterdam) International Access Code: 00 Country Code: 31 City Code: 20	Website: support.euro.dell.com	
	Technical Support for Inspiron XPS computers only	020 674 45 94
	Technical Support for all other Dell computers	020 674 45 00
	Technical Support Fax	020 674 47 66
	Home/Small Business Customer Care	020 674 42 00
	Relational Customer Care	020 674 4325
	Home/Small Business Sales	020 674 55 00
	Relational Sales	020 674 50 00
	Home/Small Business Sales Fax	020 674 47 75
	Relational Sales Fax	020 674 47 50
	Switchboard	020 674 50 00
	Switchboard Fax	020 674 47 50
New Zealand International Access Code: 00 Country Code: 64	E-mail (New Zealand): nz_tech_support@dell.com	
	E-mail (Australia): au_tech_support@dell.com	
	Technical Support (for desktop and portable computers)	toll-free: 0800 446 255
	Technical Support (for servers and workstations)	toll-free: 0800 443 563
	Home and Small Business	0800 446 255
	Government and Business	0800 444 617
Nicaragua	Sales	0800 441 567
	Fax	0800 441 566
Norway (Lysaker)	General Support	001-800-220-1006
	Website: support.euro.dell.com	
	E-mail: support.euro.dell.com/no/no/emaildell/	
	Technical Support	671 16882

International Access Code: 00	Relational Customer Care	671 17575	
Country Code: 47	Home/Small Business Customer Care	23162298	
	Switchboard	671 16800	
	Fax Switchboard	671 16865	
Panama	General Support	001-800-507-0962	
Peru	General Support	0800-50-669	
Poland (Warsaw)	Website: support.euro.dell.com		
	E-mail: pl_support_tech@dell.com		
	Customer Service Phone	57 95 700	
	International Access Code: 011	Customer Care	57 95 999
	Country Code: 48	Sales	57 95 999
	City Code: 22	Customer Service Fax	57 95 806
		Reception Desk Fax	57 95 998
		Switchboard	57 95 999
Portugal	Website: support.euro.dell.com		
	E-mail: support.euro.dell.com/pt/en/emaildell/		
	International Access Code: 00	Technical Support	707200149
	Country Code: 351	Customer Care	800 300 413
		Sales	800 300 410 or 800 300 411 or 800 300 412 or 21 422 07 10
		Fax	21 424 01 12
Puerto Rico	General Support	1-800-805-7545	
St. Kitts and Nevis	General Support	toll-free: 1-877-441-4731	
St. Lucia	General Support	1-800-882-1521	
St. Vincent and the Grenadines	General Support	toll-free: 1-877-270-4609	
Singapore (Singapore)	Website: support.ap.dell.com		
	Technical Support (Dimension, Inspiron, and Electronics and Accessories)	toll-free: 1800 394 7430	
	International Access Code: 005	Technical Support (OptiPlex, Latitude, and Dell Precision)	toll-free: 1800 394 7488
	Country Code: 65	Technical Support (PowerApp, PowerEdge, PowerConnect, and PowerVault)	toll-free: 1800 394 7478
		Customer Service (Penang, Malaysia)	604 633 4949
		Transaction Sales	toll-free: 1 800 394 7412
		Corporate Sales	toll-free: 1 800 394 7419
Slovakia (Prague)	Website: support.euro.dell.com		
	E-mail: czech_dell@dell.com		
	International Access Code: 00	Technical Support	02 5441 5727
	Country Code: 421	Customer Care	420 22537 2707
		Fax	02 5441 8328
		Tech Fax	02 5441 8328
	Switchboard (Sales)	02 5441 7585	
South Africa (Johannesburg)	Website: support.euro.dell.com		
	E-mail: dell_za_support@dell.com		
	International Access Code: 09/091	Gold Queue	011 709 7713
	Country Code: 27	Technical Support	011 709 7710
	City Code: 11	Customer Care	011 709 7707
		Sales	011 709 7700
		Fax	011 706 0495
		Switchboard	011 709 7700
Southeast Asian and Pacific Countries	Customer Technical Support, Customer Service, and Sales (Penang, Malaysia)	604 633 4810	
Spain (Madrid)	Website: support.euro.dell.com		
	E-mail: support.euro.dell.com/es/es/emaildell/		
		Home and Small Business	
	International Access Code: 00	Technical Support	902 100 130
	Country Code: 34	Customer Care	902 118 540
	City Code: 91	Sales	902 118 541
		Switchboard	902 118 541
		Fax	902 118 539
		Corporate	
		Technical Support	902 100 130

	Customer Care	902 115 236
	Switchboard	91 722 92 00
	Fax	91 722 95 83
Sweden (Upplands Vasby) International Access Code: 00 Country Code: 46 City Code: 8	Website: support.euro.dell.com	
	E-mail: support.euro.dell.com/se/sv/emaiddell/	
	Technical Support	08 590 05 199
	Relational Customer Care	08 590 05 642
	Home/Small Business Customer Care	08 587 70 527
	Employee Purchase Program (EPP) Support	20 140 14 44
	Technical Support Fax	08 590 05 594
	Sales	08 590 05 185
Switzerland (Geneva) International Access Code: 00 Country Code: 41 City Code: 22	Website: support.euro.dell.com	
	E-mail: Tech_support_central_Europe@dell.com	
	E-mail for French-speaking HSB and Corporate Customers: support.euro.dell.com/ch/fr/emaiddell/	
	Technical Support (Home and Small Business)	0844 811 411
	Technical Support (Corporate)	0844 822 844
	Customer Care (Home and Small Business)	0848 802 202
	Customer Care (Corporate)	0848 821 721
	Fax	022 799 01 90
Switchboard	022 799 01 01	
Taiwan International Access Code: 002 Country Code: 886	Website: support.ap.dell.com	
	E-mail: ap_support@dell.com	
	Technical Support (OptiPlex, Latitude, Inspiron, Dimension, and Electronics and Accessories)	toll-free: 00801 86 1011
	Technical Support (PowerApp, PowerEdge, PowerConnect, and PowerVault)	toll-free: 00801 60 1256
	Transaction Sales	toll-free: 00801 65 1228
Corporate Sales	toll-free: 00801 651 227	
Thailand International Access Code: 001 Country Code: 66	Website: support.ap.dell.com	
	Technical Support (OptiPlex, Latitude, and Dell Precision)	toll-free: 1800 0060 07
	Technical Support (PowerApp, PowerEdge, PowerConnect, and PowerVault)	toll-free: 1800 0600 09
	Customer Service (Penang, Malaysia)	604 633 4949
	Corporate Sales	toll-free: 1800 006 009
Transaction Sales	toll-free: 1800 006 006	
Trinidad/Tobago	General Support	1-800-805-8035
Turks and Caicos Islands	General Support	toll-free: 1-866-540-3355
U.K. (Bracknell) International Access Code: 00 Country Code: 44 City Code: 1344	Website: support.euro.dell.com	
	Customer Care website: support.euro.dell.com/uk/en/ECare/Form/Home.asp	
	E-mail: dell_direct_support@dell.com	
	Technical Support (Corporate/Preferred Accounts/PAD [1000+ employees])	0870 908 0500
	Technical Support (direct and general)	0870 908 0800
	Global Accounts Customer Care	01344 373 186
	Home and Small Business Customer Care	0870 906 0010
	Corporate Customer Care	01344 373 185
	Preferred Accounts (500-5000 employees) Customer Care	0870 906 0010
	Central Government Customer Care	01344 373 193
	Local Government & Education Customer Care	01344 373 199
	Health Customer Care	01344 373 194
	Home and Small Business Sales	0870 907 4000
	Corporate/Public Sector Sales	01344 860 456
Home and Small Business Fax	0870 907 4006	
Uruguay	General Support	toll-free: 000-413-598-2521
	Automated Order-Status Service	toll-free: 1-800-433-9014
	AutoTech (portable and desktop computers)	toll-free: 1-800-247-9362
	Consumer (Home and Home Office)	
	Technical Support	toll-free: 1-800-624-9896
	Customer Service	toll-free: 1-800-624-9897
	DellNet™ Service and Support	toll-free: 1-877-DellNet

		(1-877-335-5638)
	Employee Purchase Program (EPP) Customers	toll-free: 1-800-695-8133
	Financial Services website: www.dellfinancialservices.com	
	Financial Services (lease/loans)	toll-free: 1-877-577-3355
	Financial Services (Dell Preferred Accounts [DPA])	toll-free: 1-800-283-2210
U.S.A. (Austin, Texas)	Business	
	Customer Service and Technical Support	toll-free: 1-800-822-8965
International Access Code: 011	Employee Purchase Program (EPP) Customers	toll-free: 1-800-695-8133
Country Code: 1	Printers and Projectors Technical Support	toll-free: 1-877-459-7298
	Public (government, education, and healthcare)	
	Customer Service and Technical Support	toll-free: 1-800-456-3355
	Employee Purchase Program (EPP) Customers	toll-free: 1-800-234-1490
	Dell Sales	toll-free: 1-800-289-3355 or toll-free: 1-800-879-3355
	Dell Outlet Store (Dell refurbished computers)	toll-free: 1-888-798-7561
	Software and Peripherals Sales	toll-free: 1-800-671-3355
	Spare Parts Sales	toll-free: 1-800-357-3355
	Extended Service and Warranty Sales	toll-free: 1-800-247-4618
	Fax	toll-free: 1-800-727-8320
	Dell Services for the Deaf, Hard-of-Hearing, or Speech-Impaired	toll-free: 1-877-DELLTTY (1-877-335-5889)
U.S. Virgin Islands	General Support	1-877-673-3355
Venezuela	General Support	8001-3605

[Back to Contents Page](#)